

Серия «Папка дошкольника»

Послушный карандаш

Задания на подготовку руки к письму

Для
детей
4-5
лет



Солнечные
ступеньки®

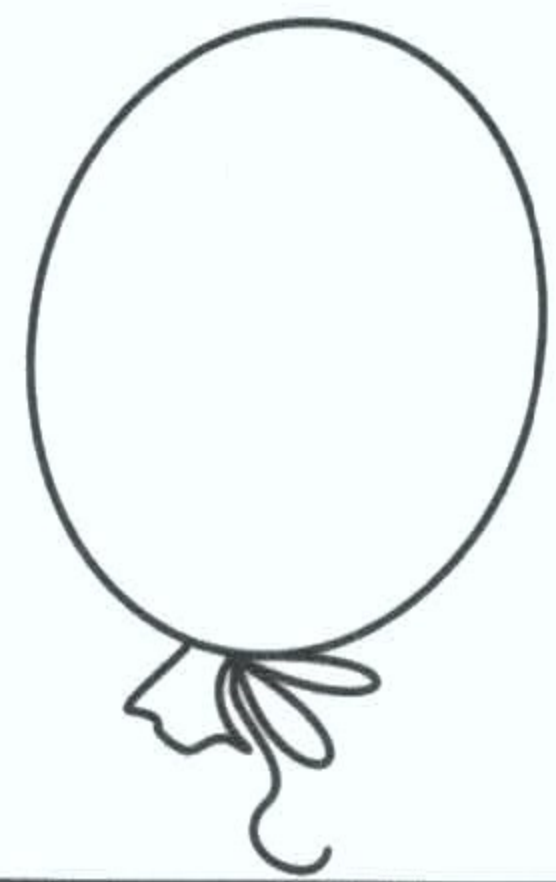
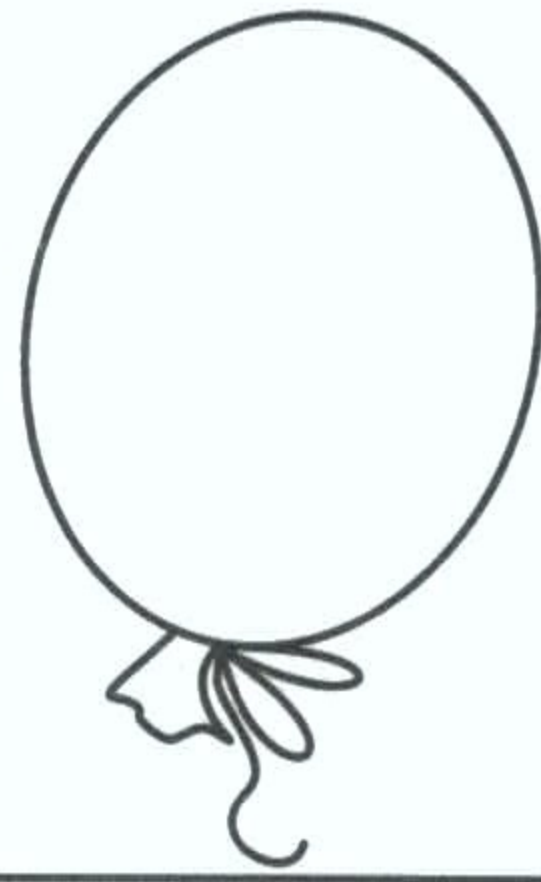
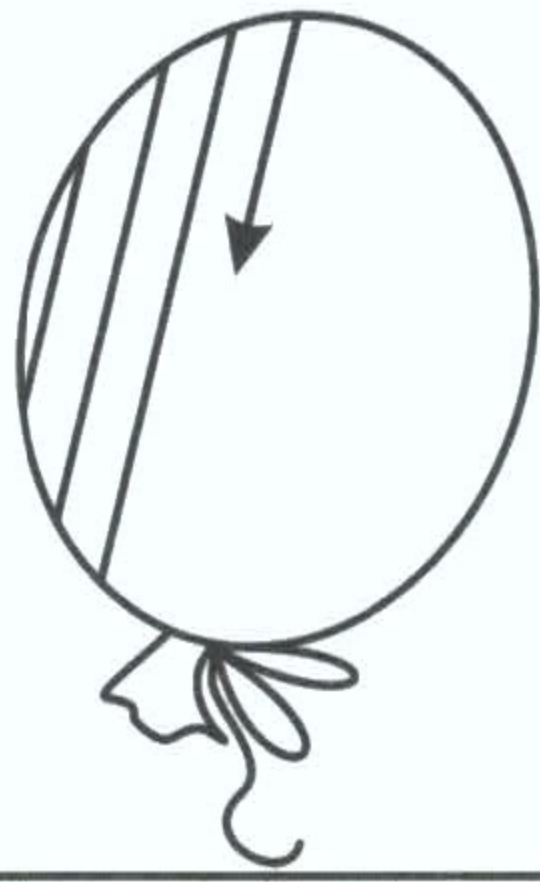

Проведи линии и ты узнаешь, кто куда идёт.

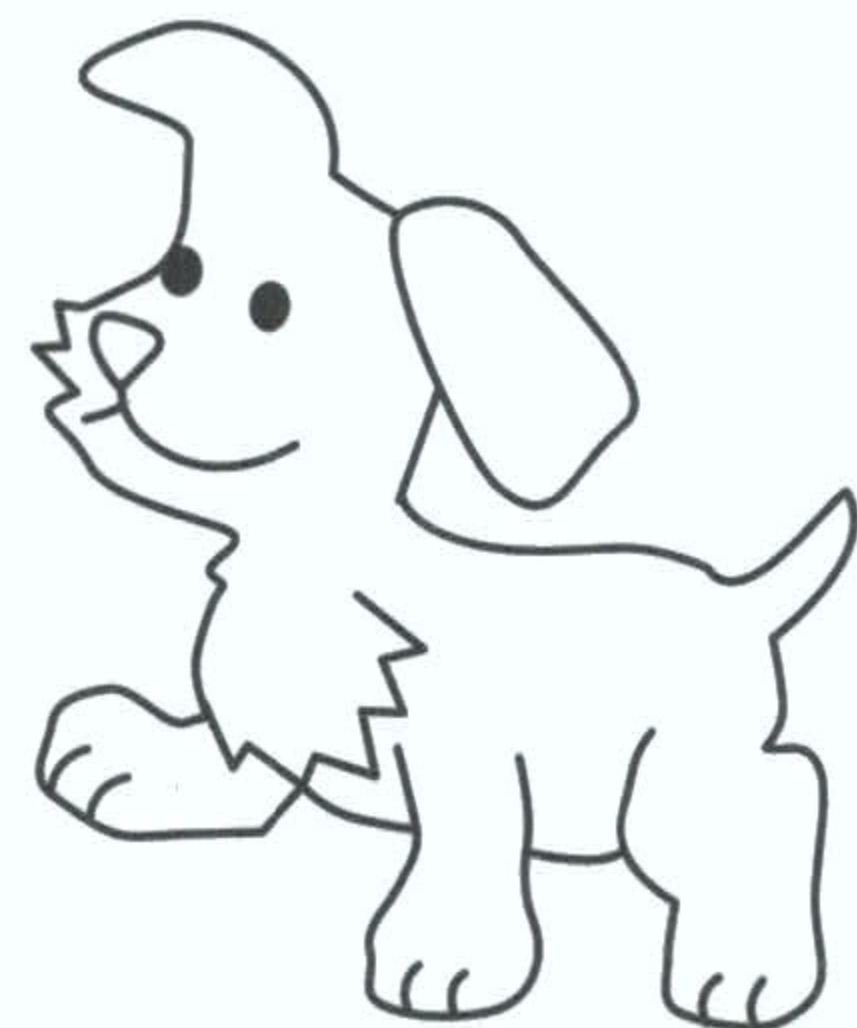
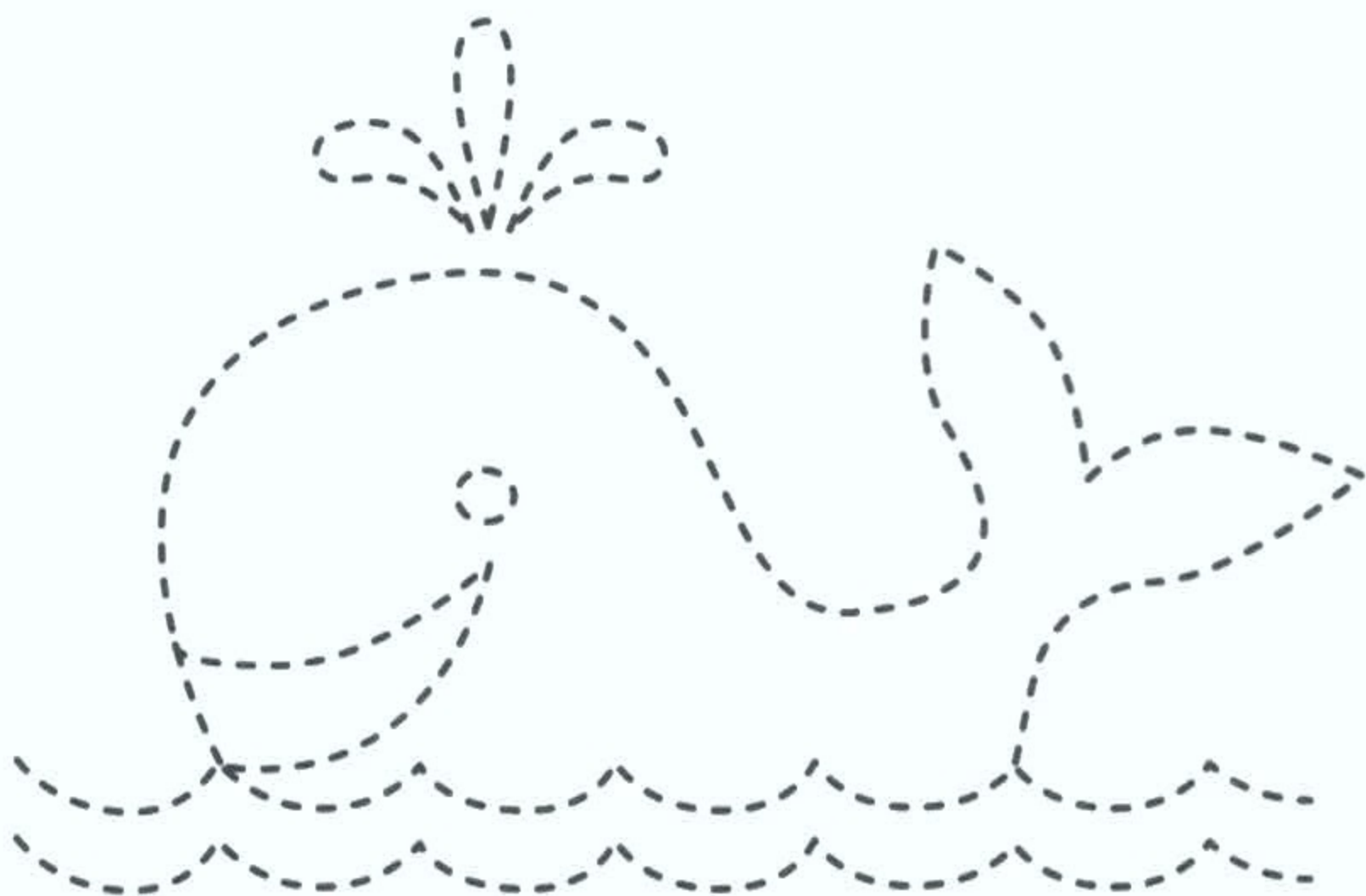
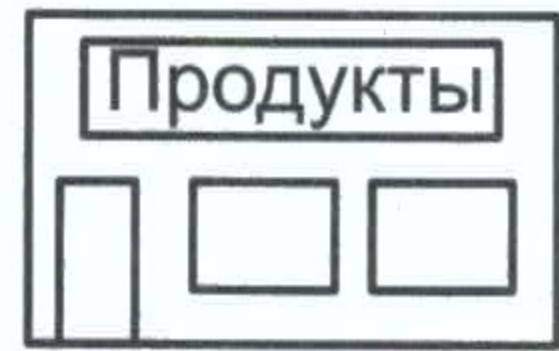
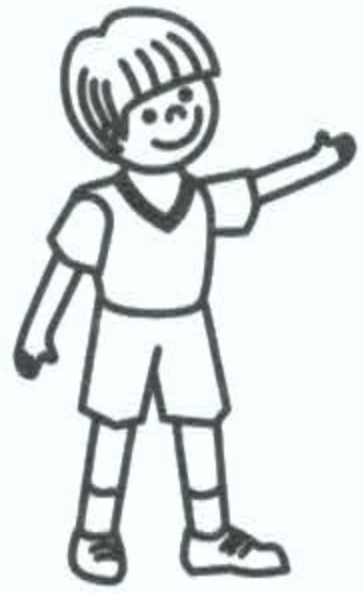

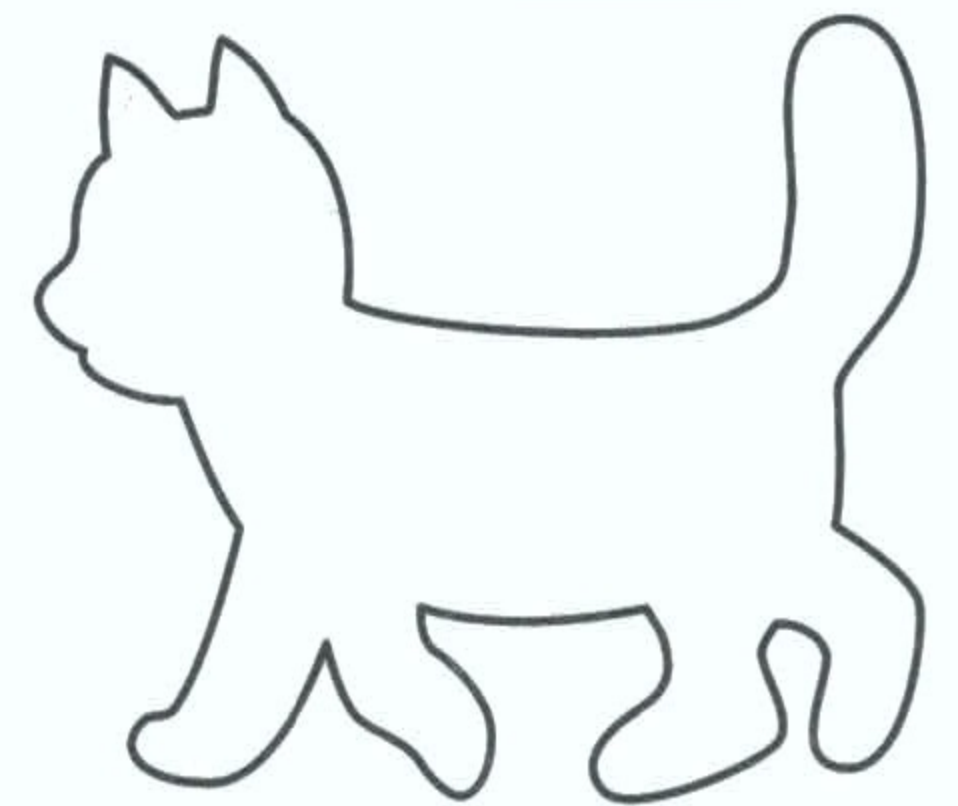
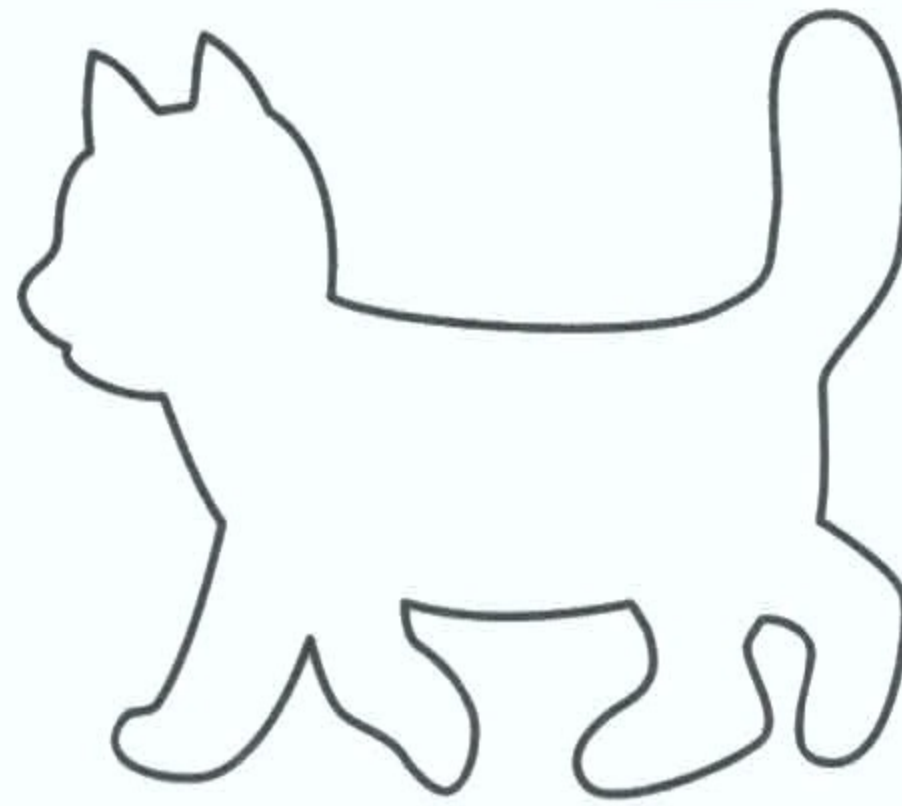
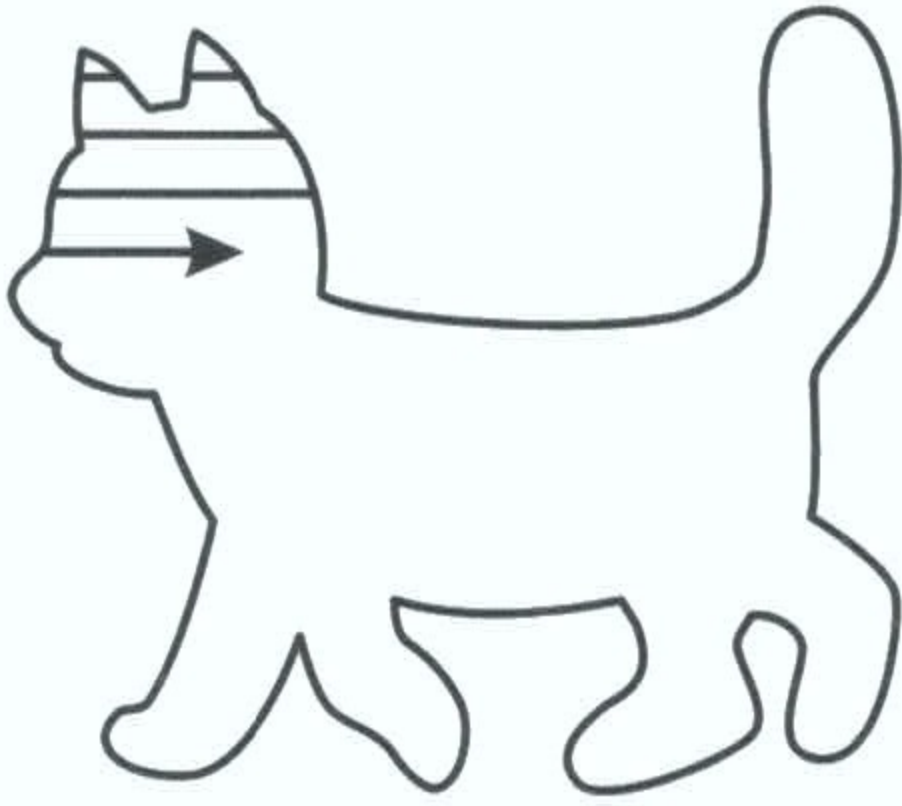

Обведи клубочки по пунктирным линиям.

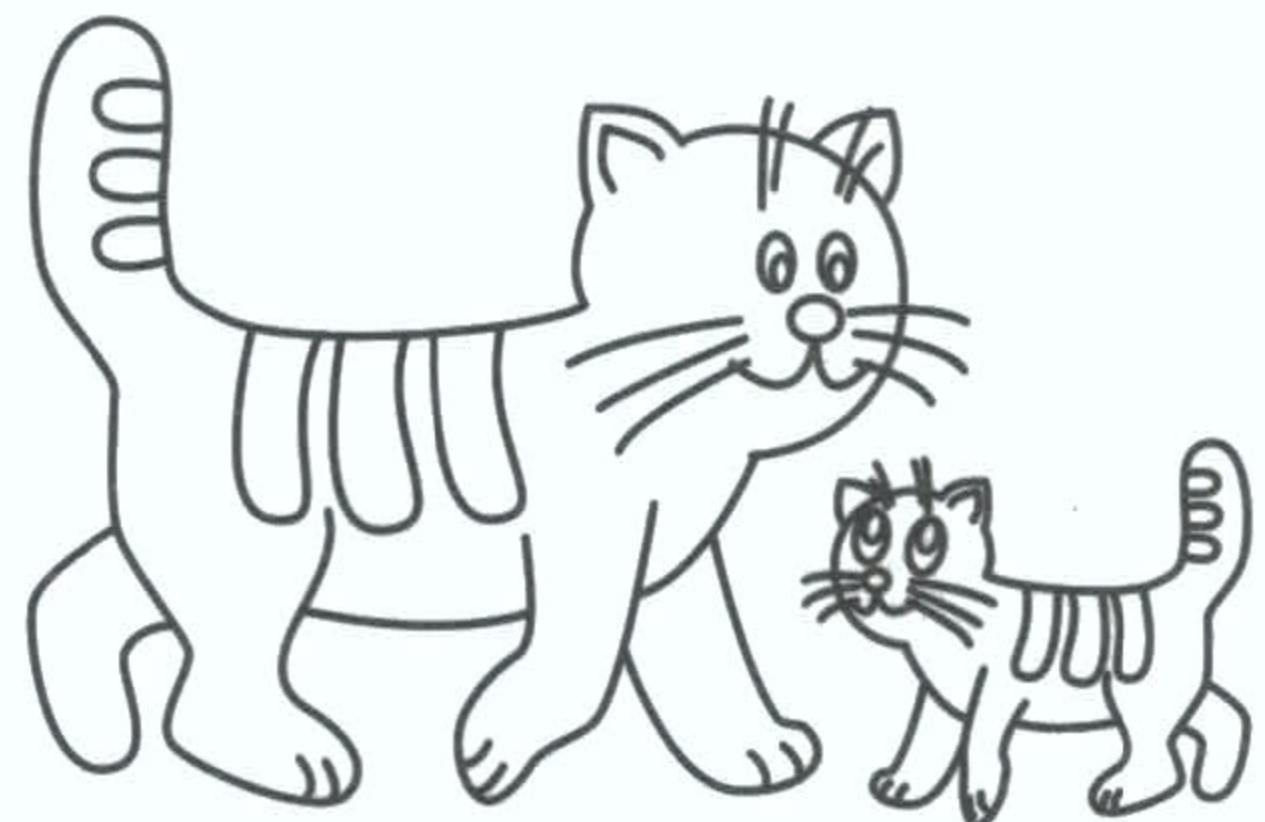
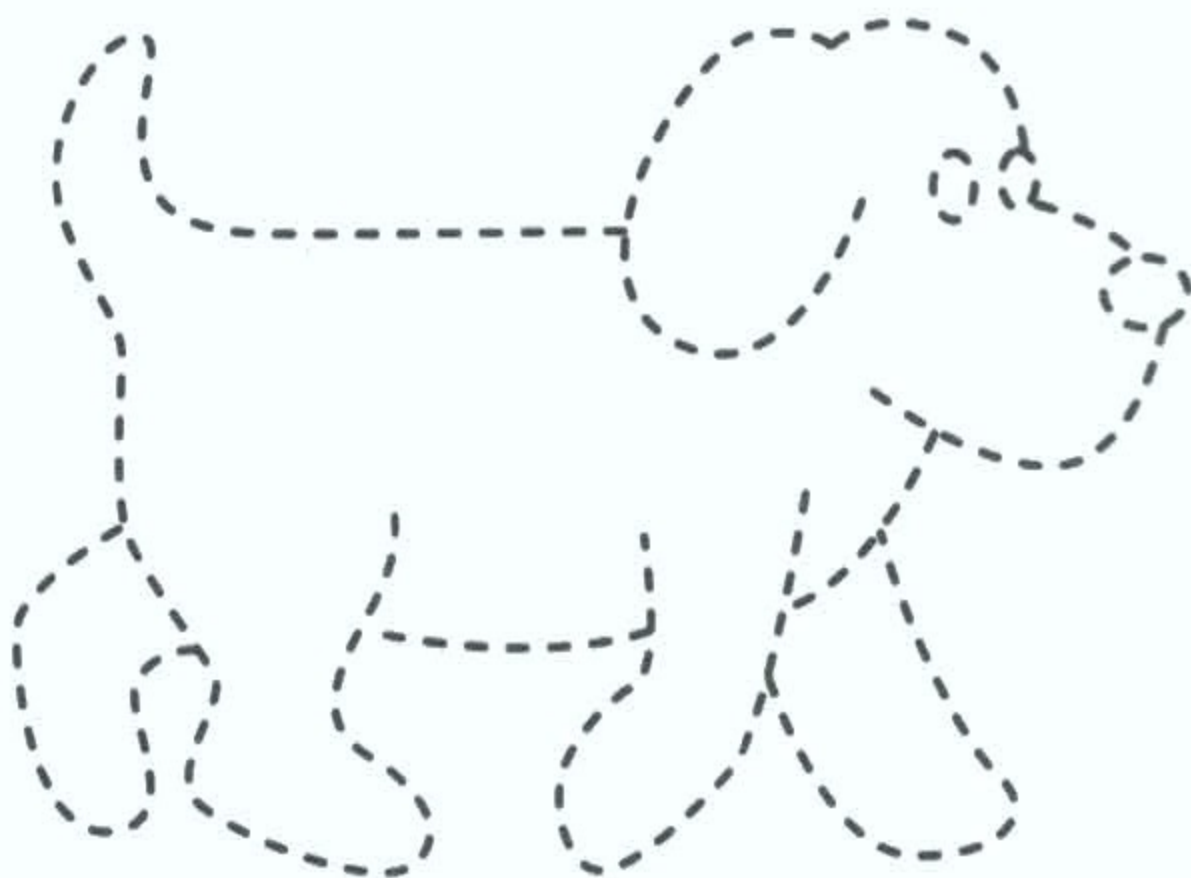
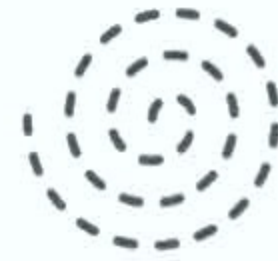
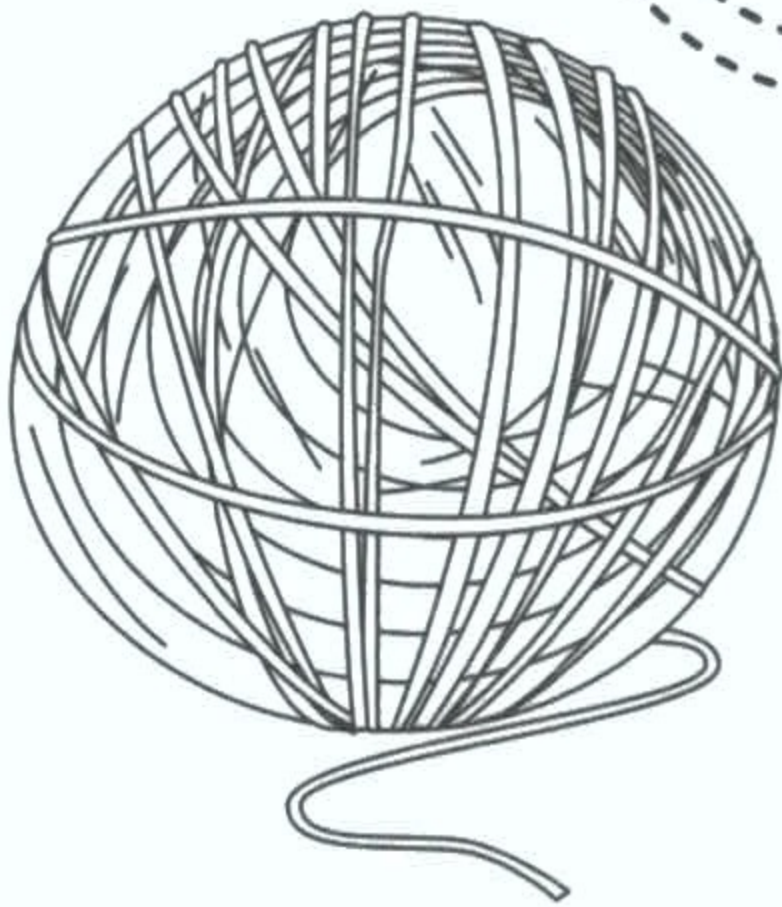
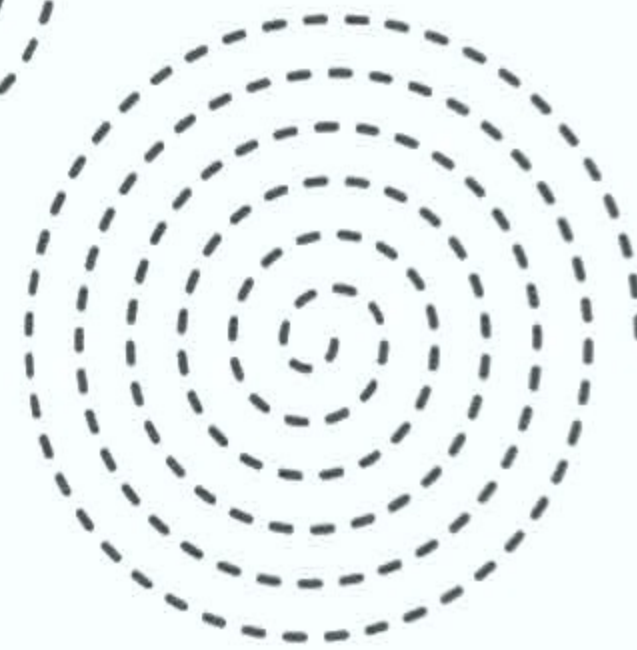

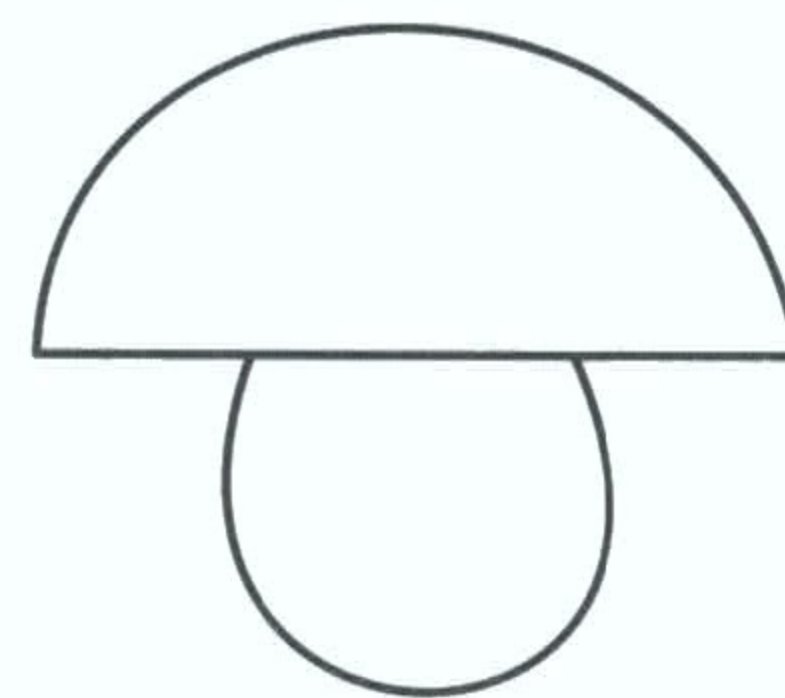
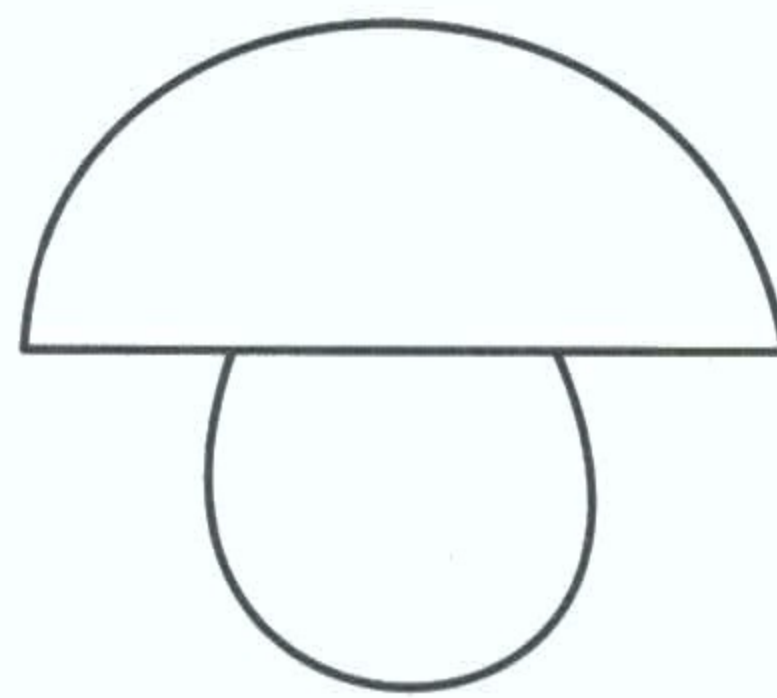
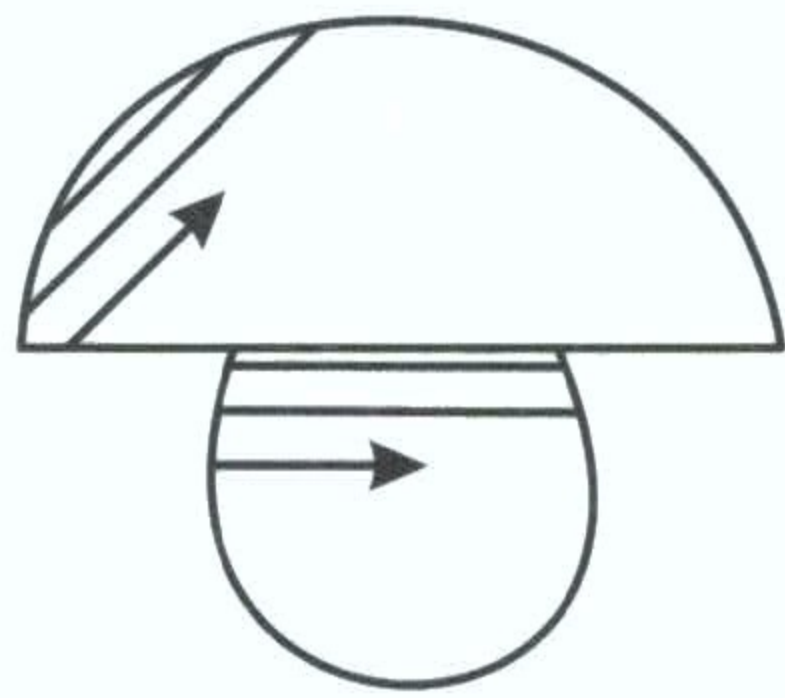

Дорисуй и раскрась картинку.

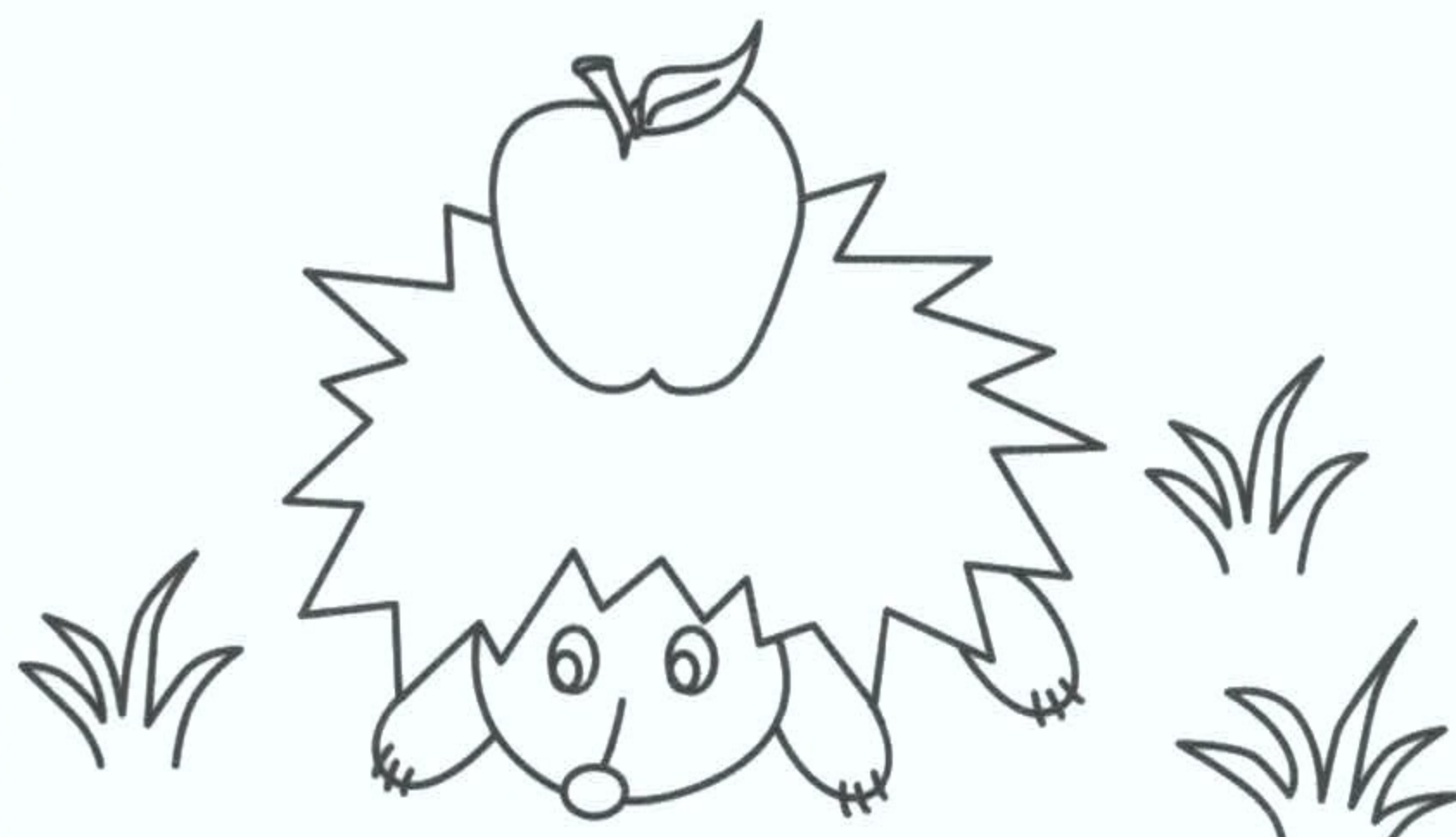
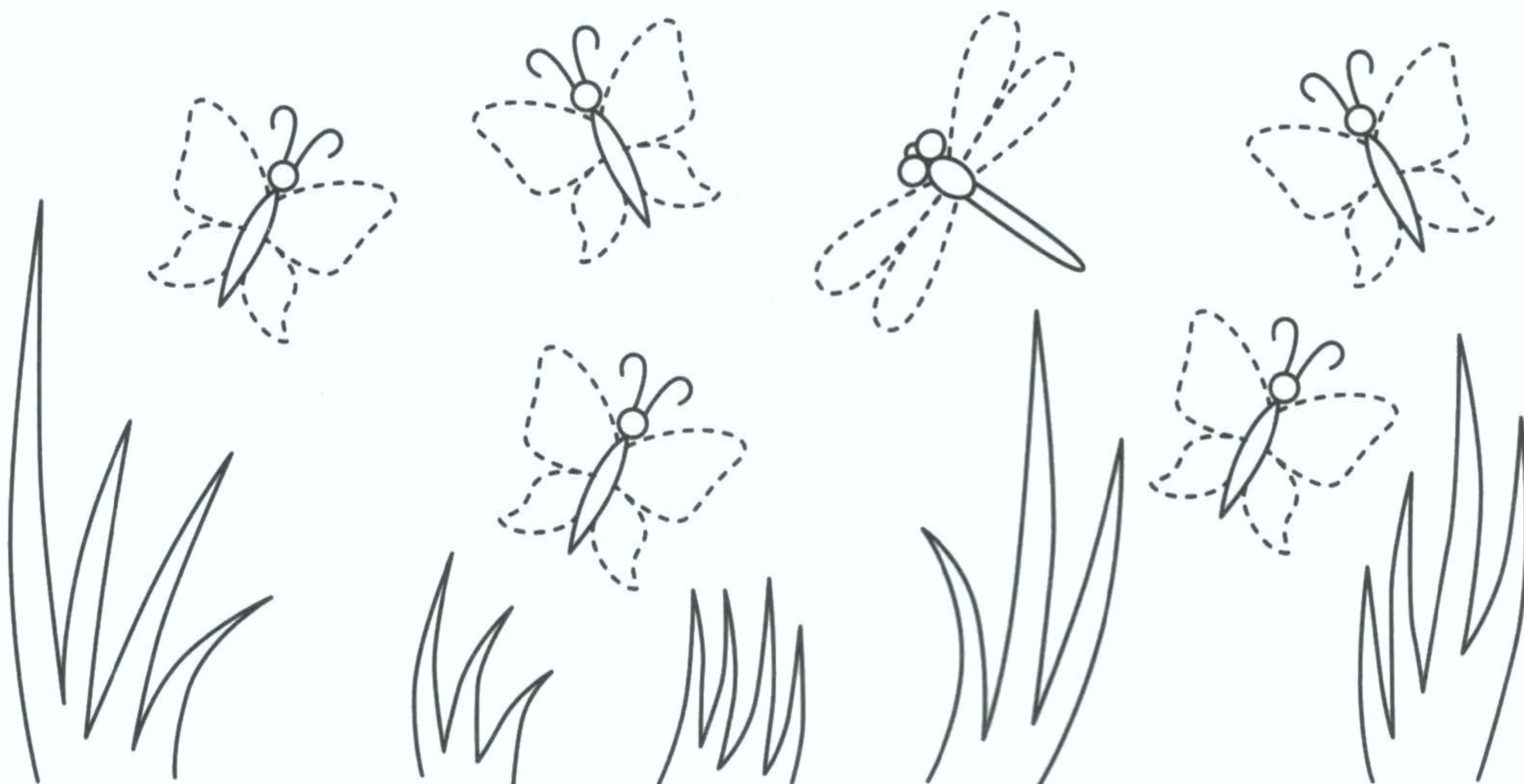

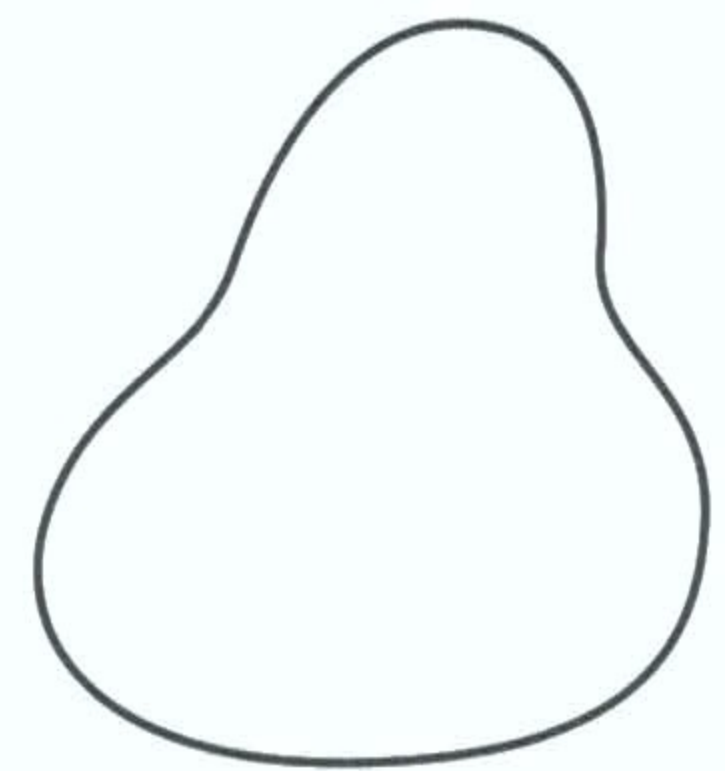
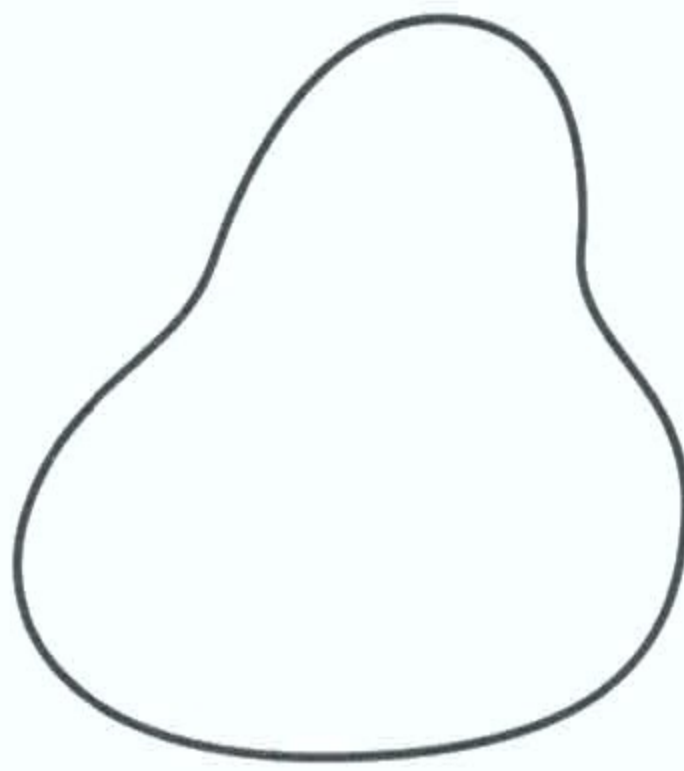
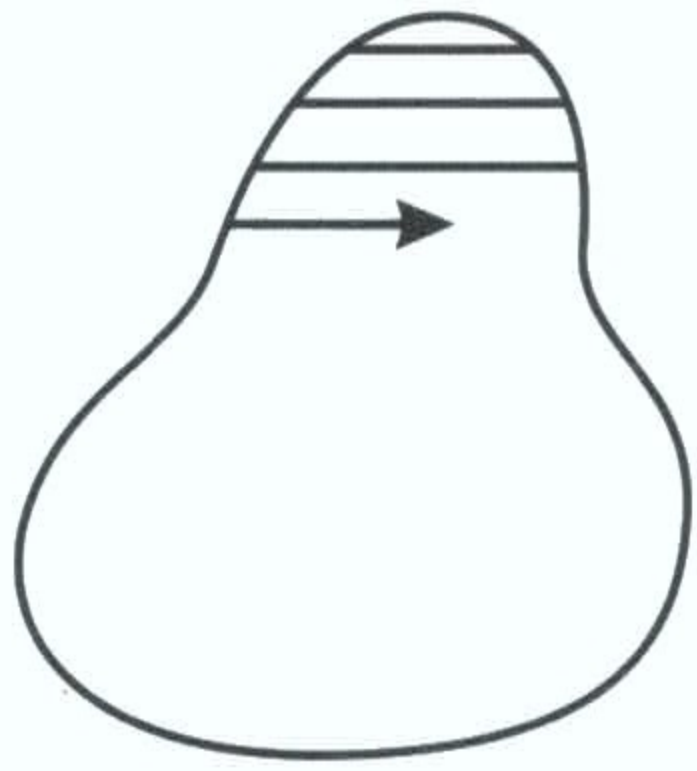

Раскрась по цифрам.

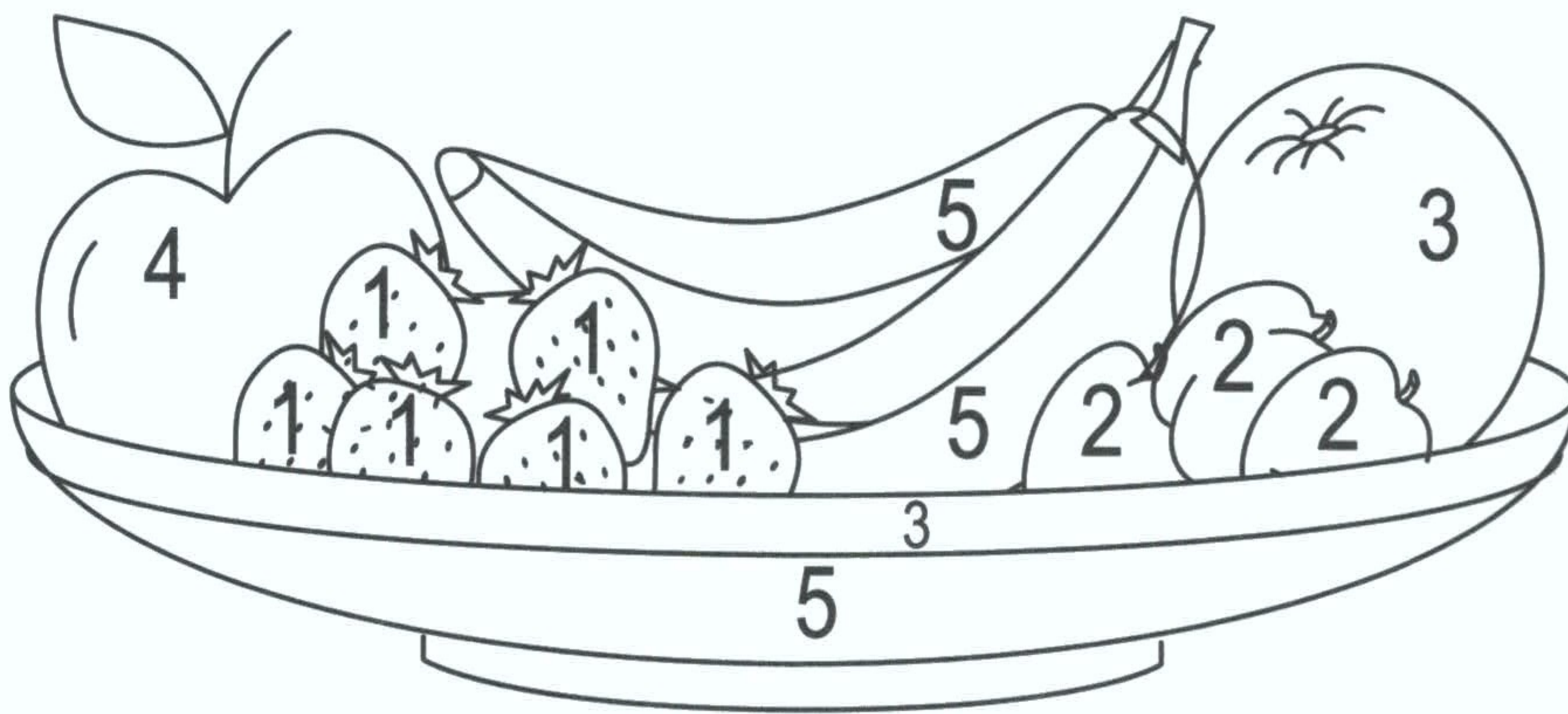

- 1 - красный
- 2 - синий
- 3 - оранжевый
- 4 - зелёный
- 5 - жёлтый

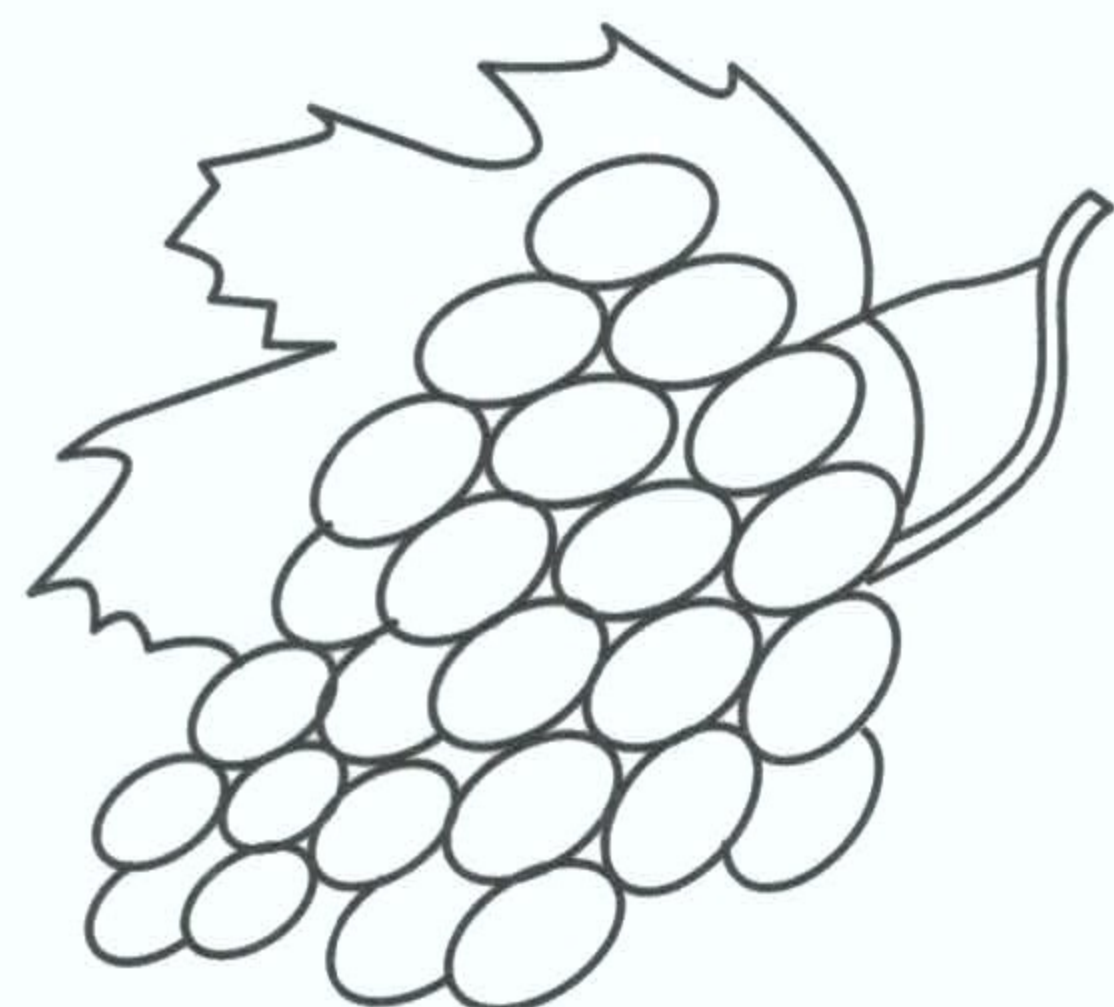
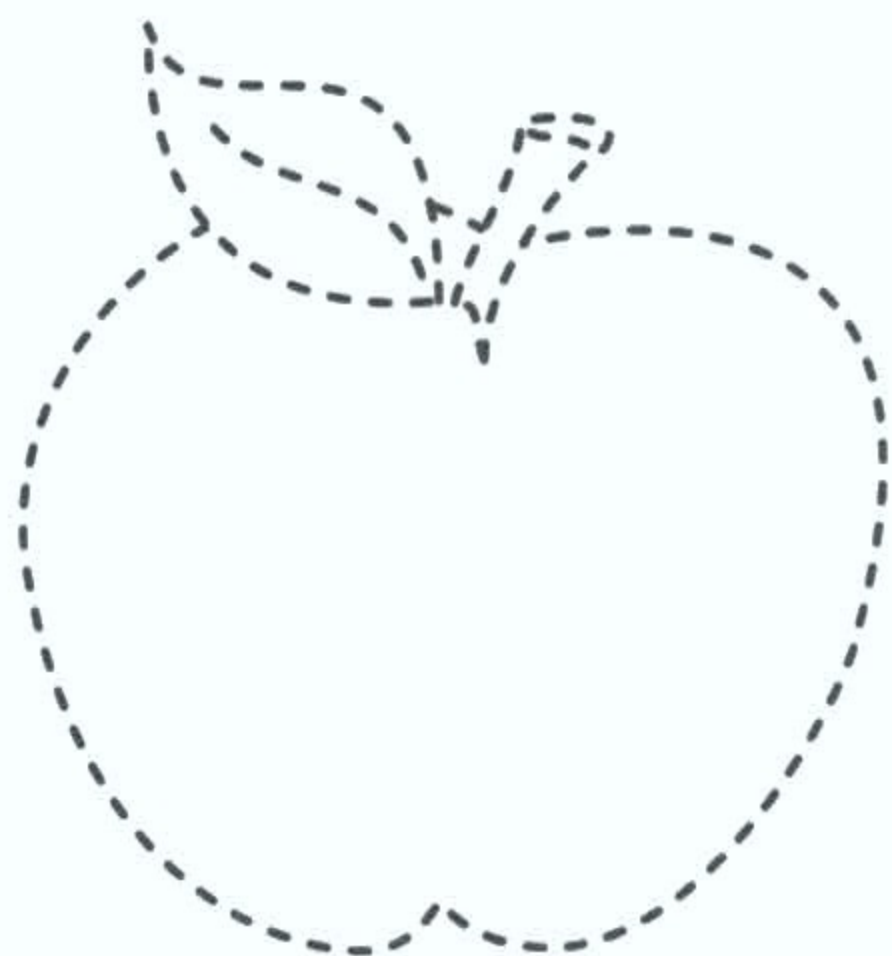

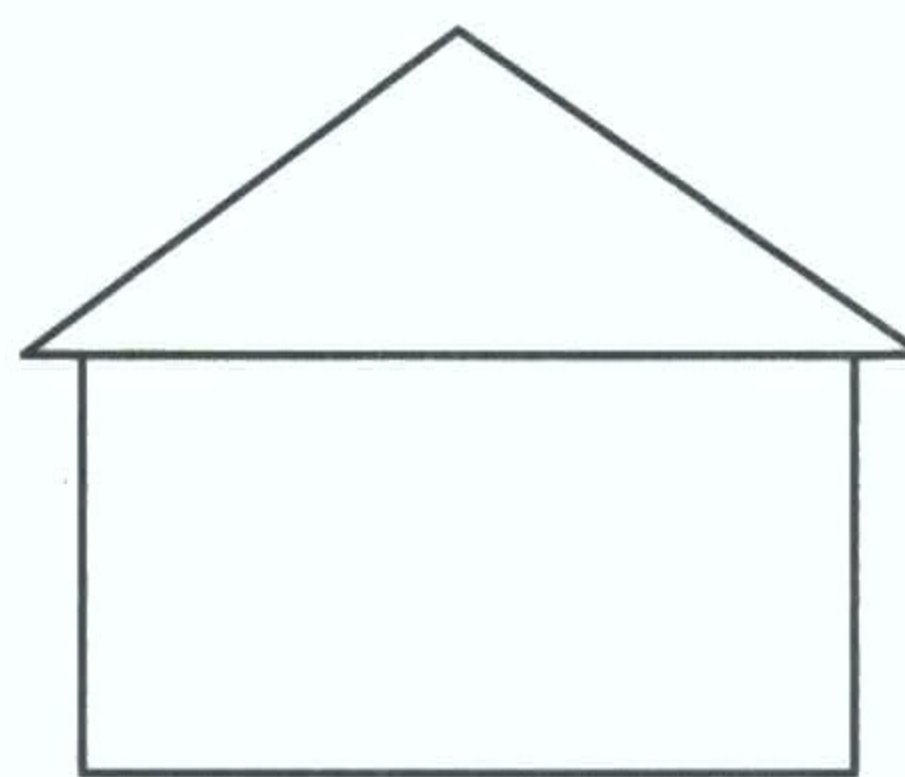
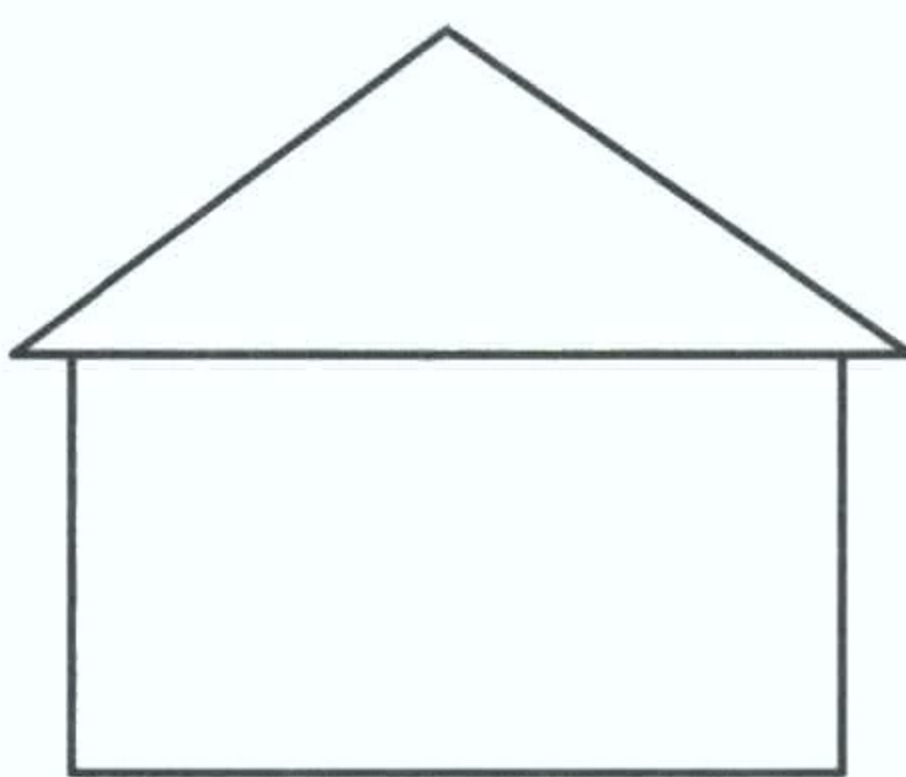
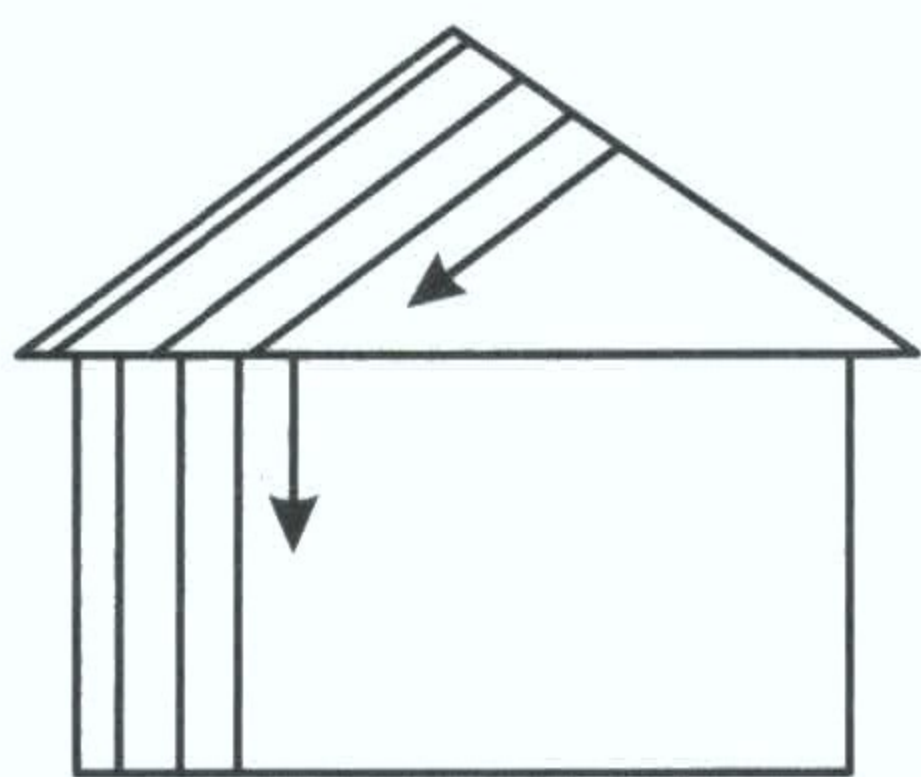

Помоги машине доехать до гаража. Проведи линию, не касаясь краёв дорожки и не отрывая карандаш от бумаги.

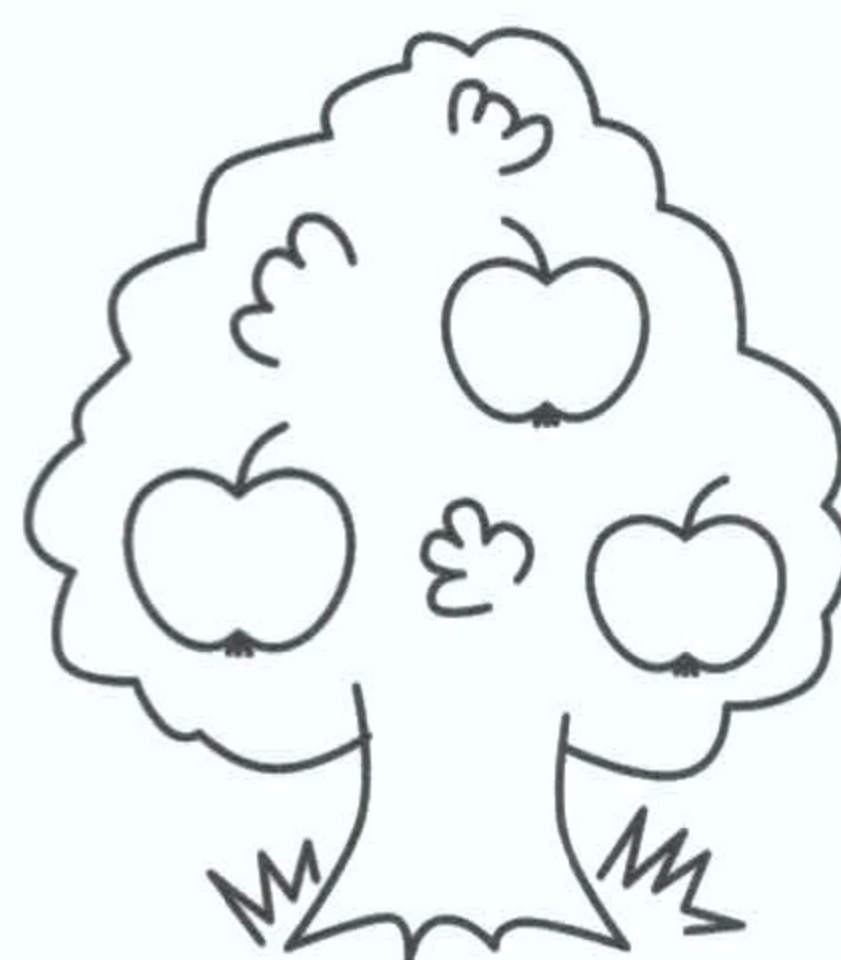
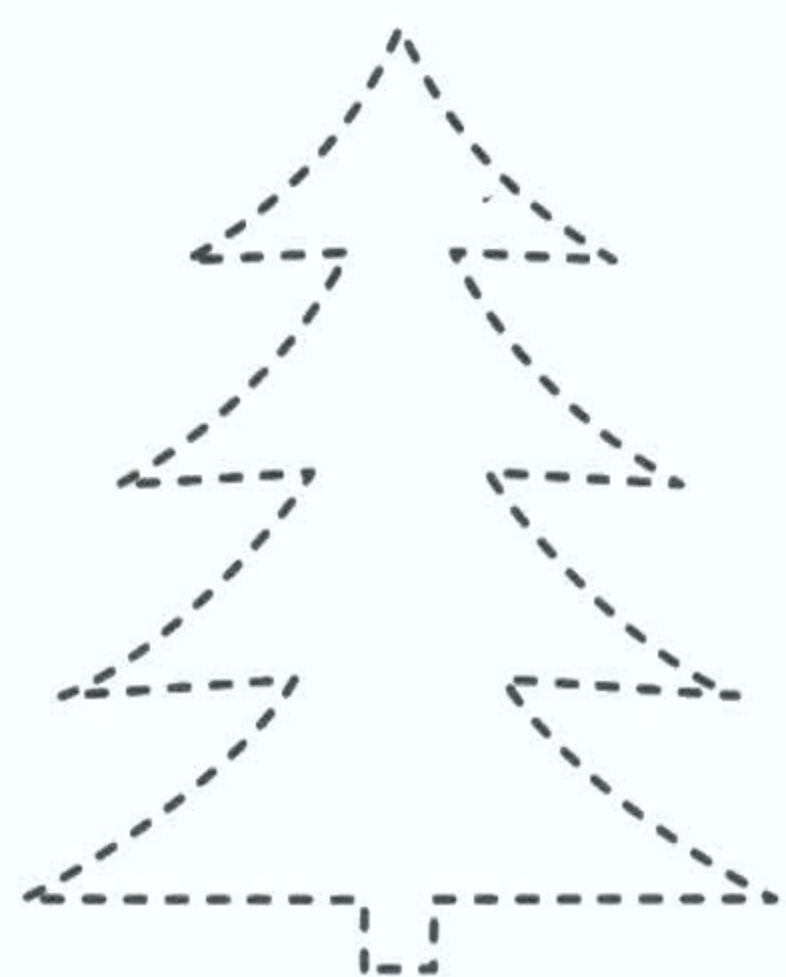
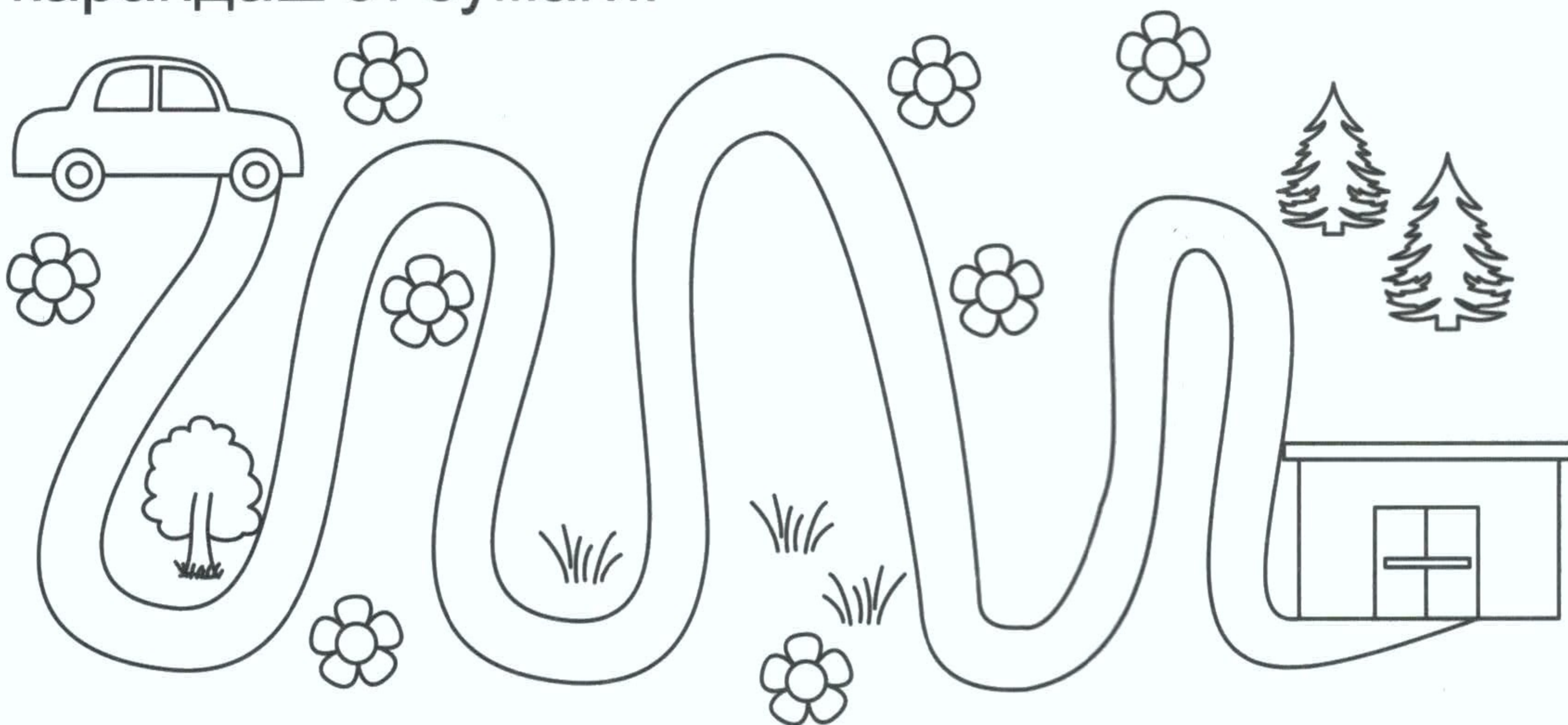

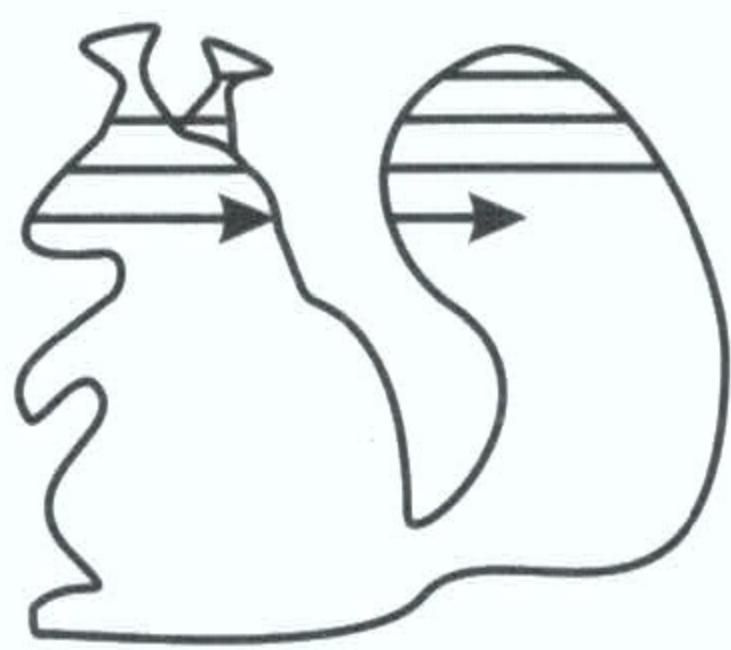

Обведи рисунки по пунктирным линиям.

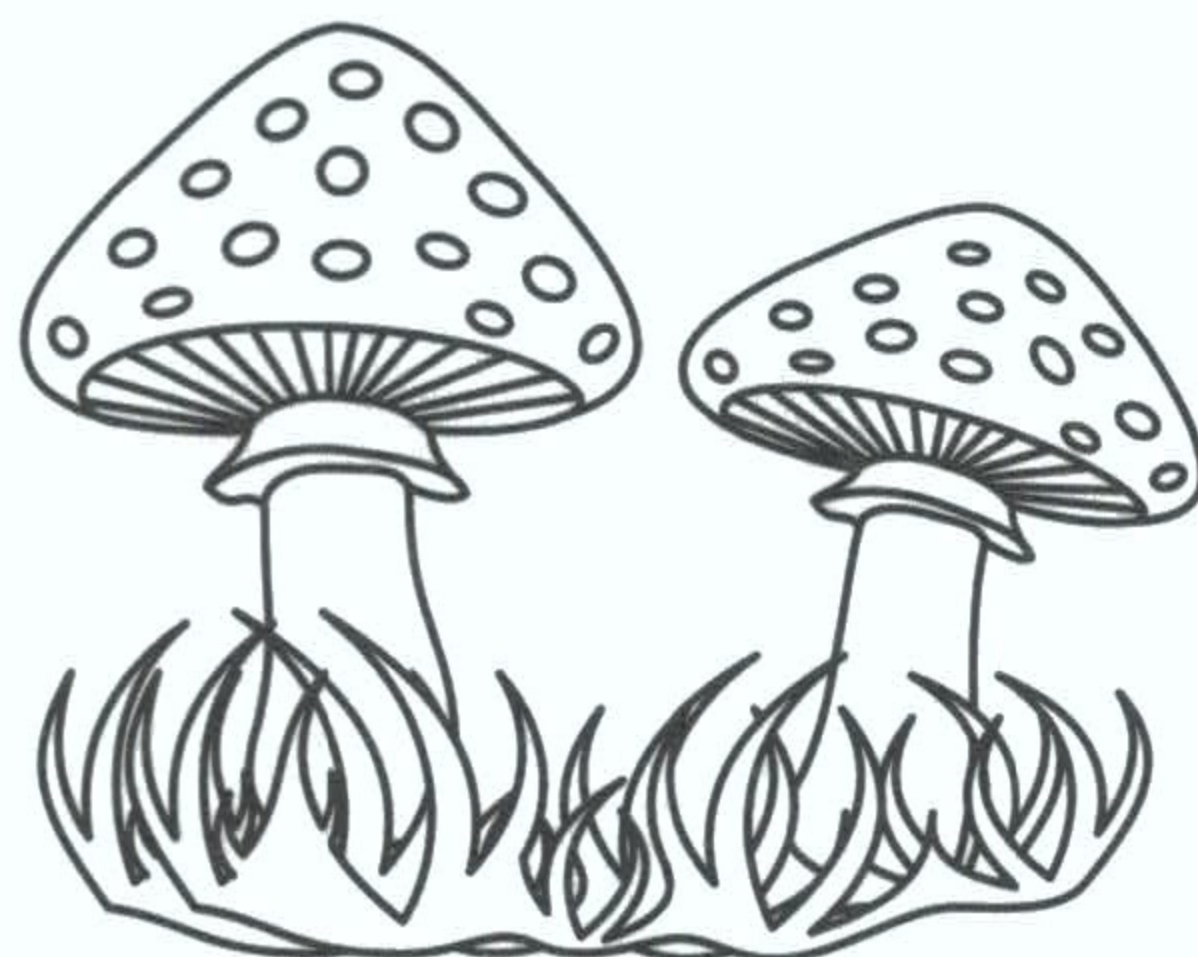
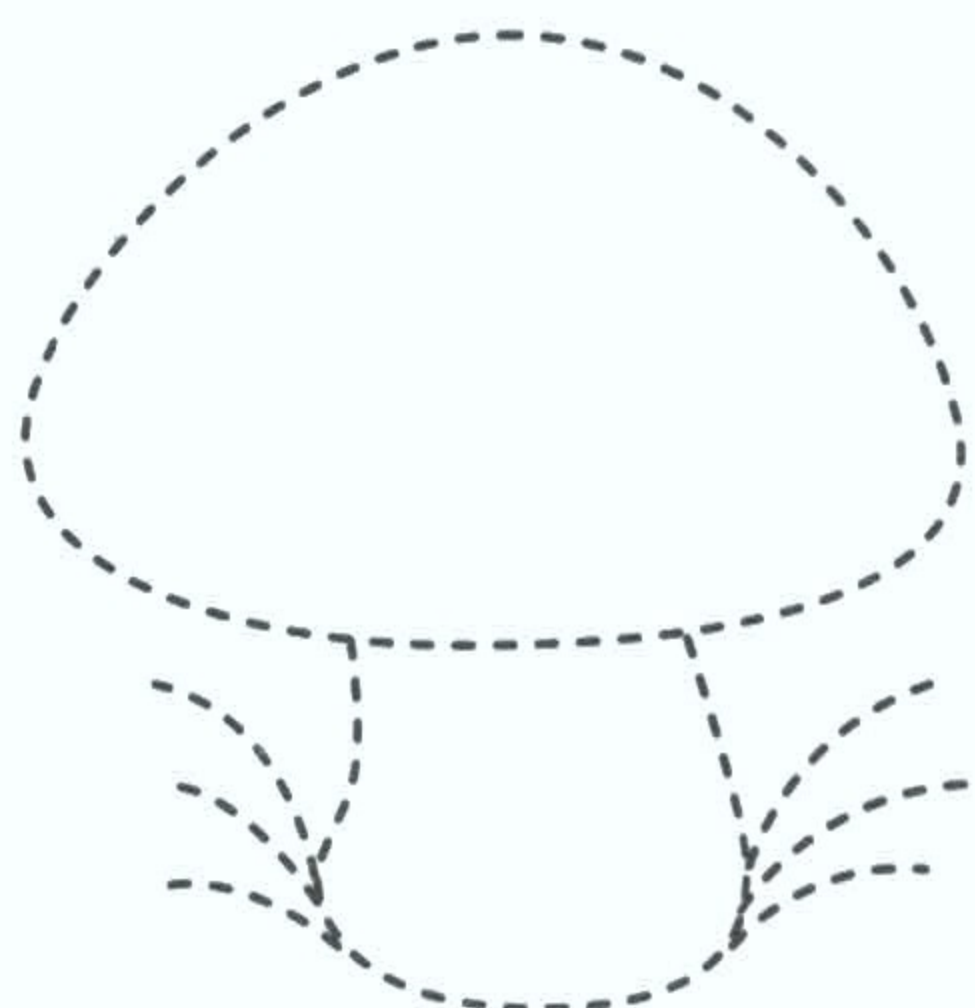
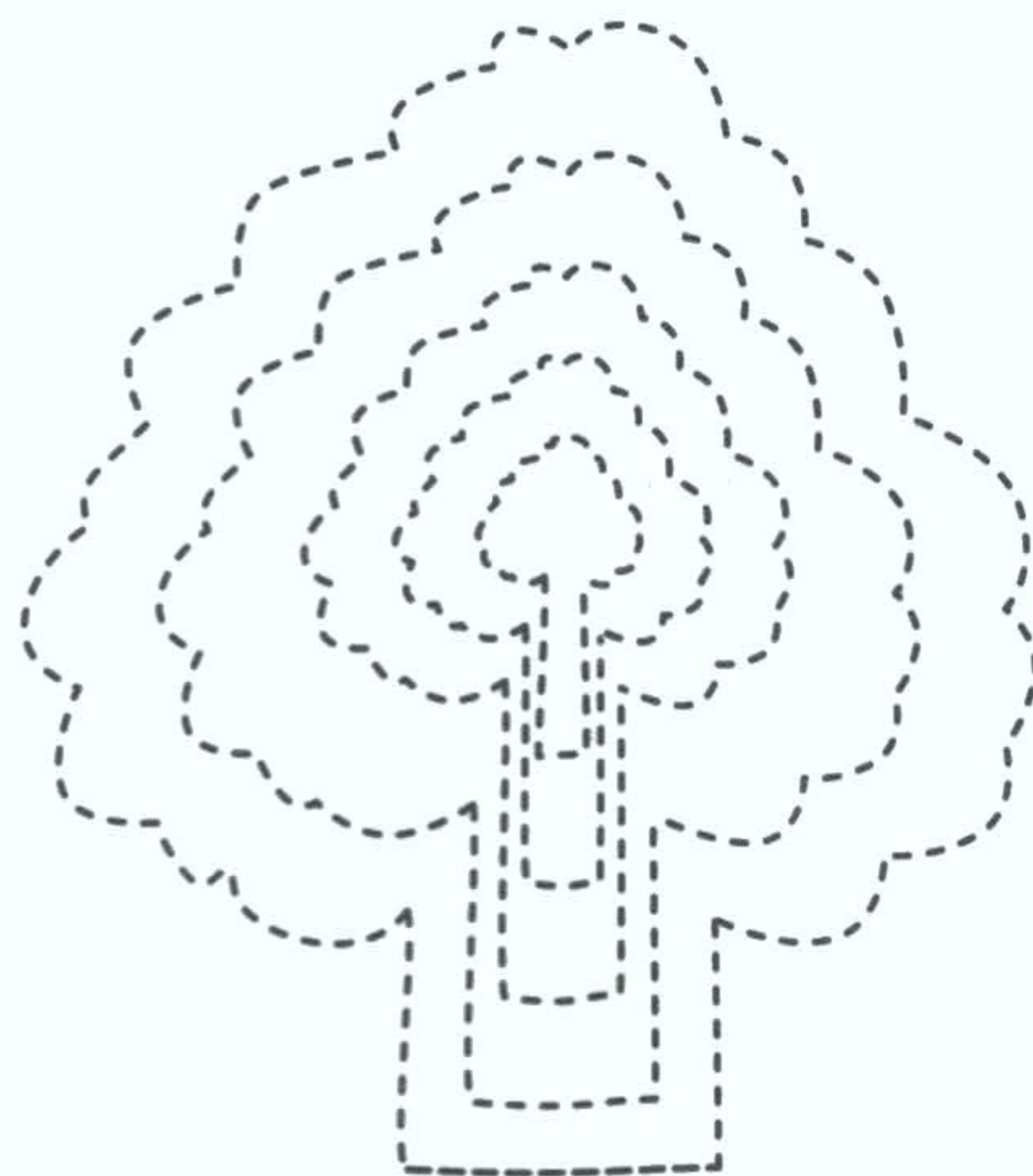
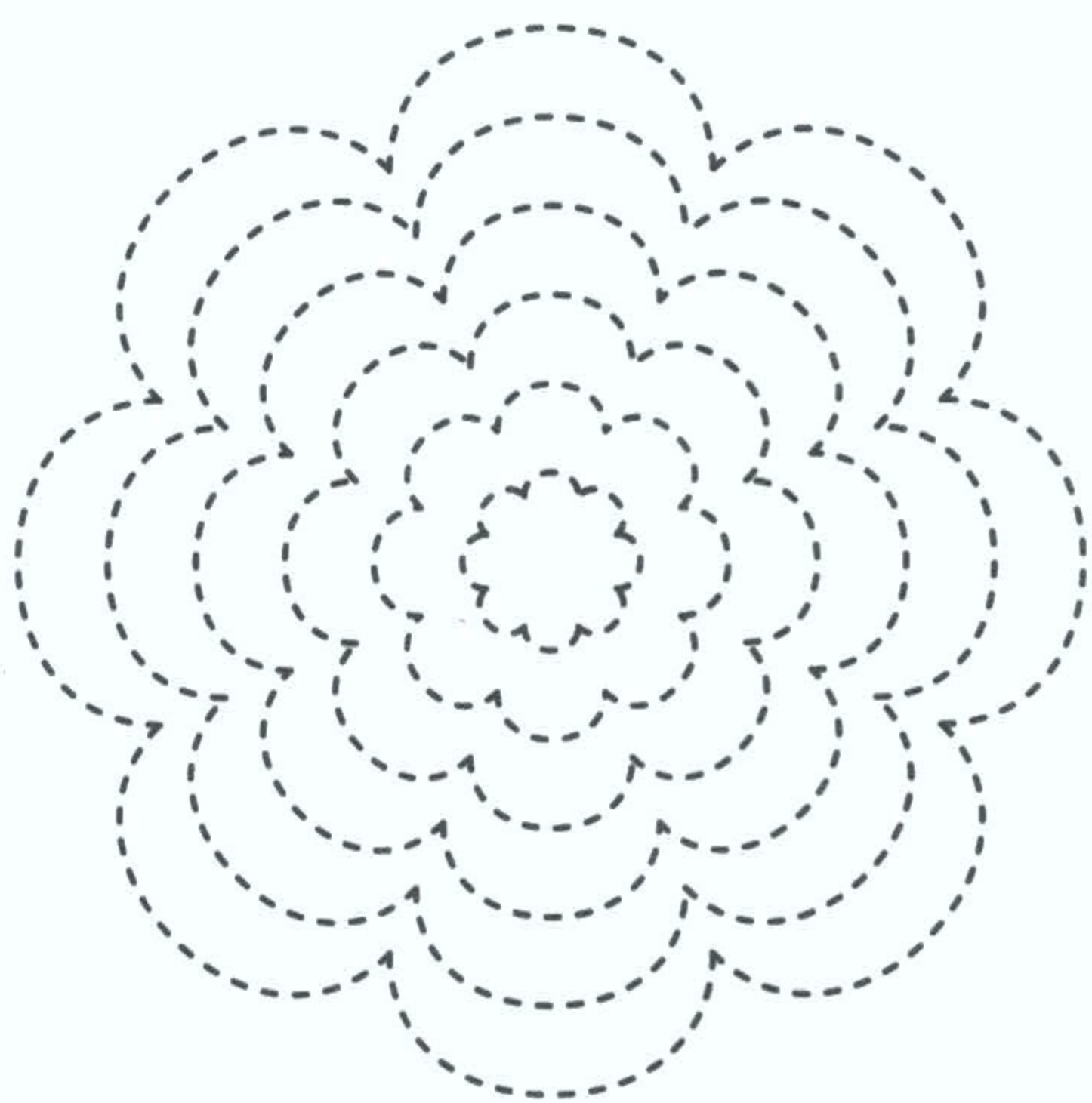

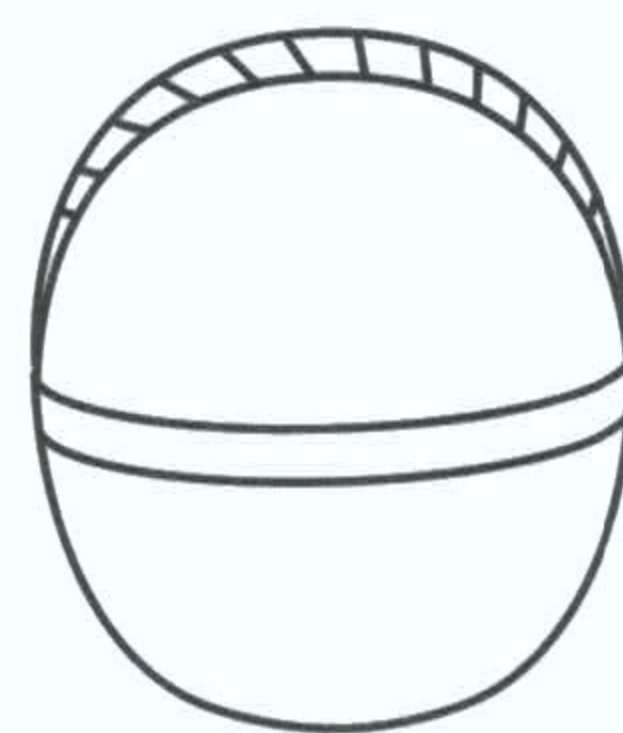
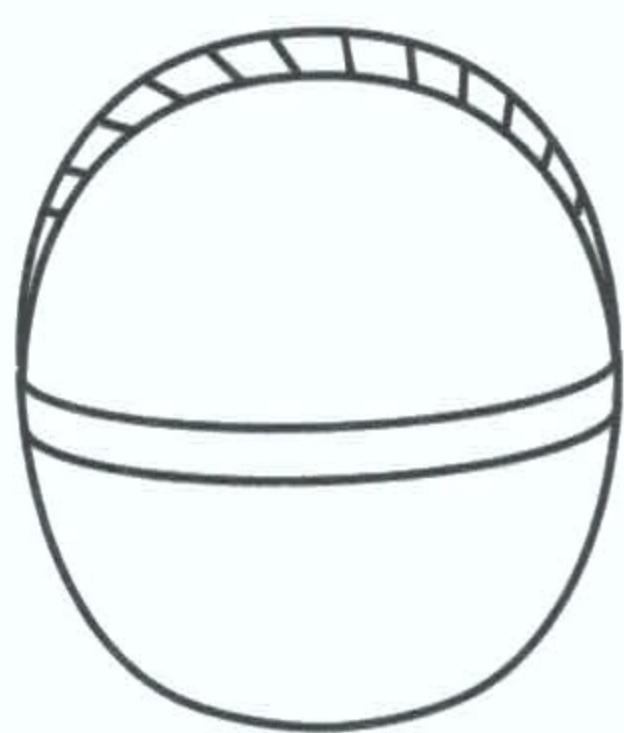
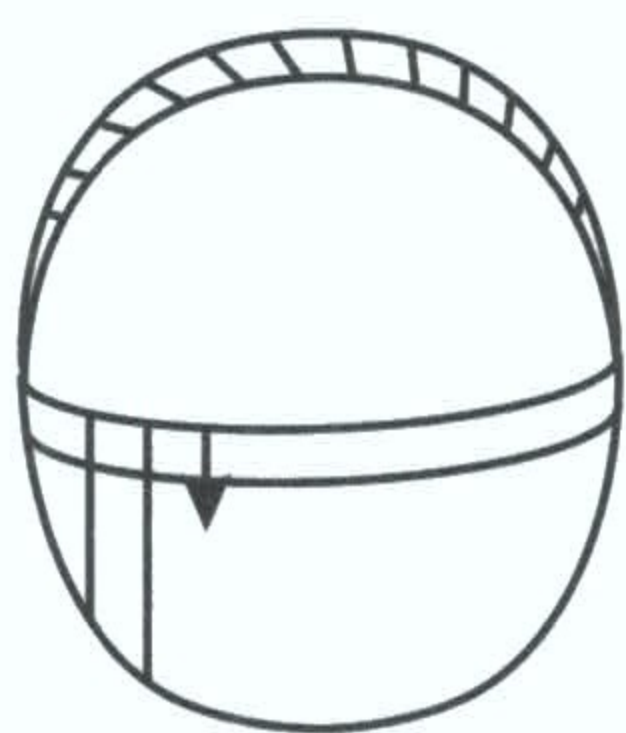

Раскрась одинаковые фигуры одним цветом.

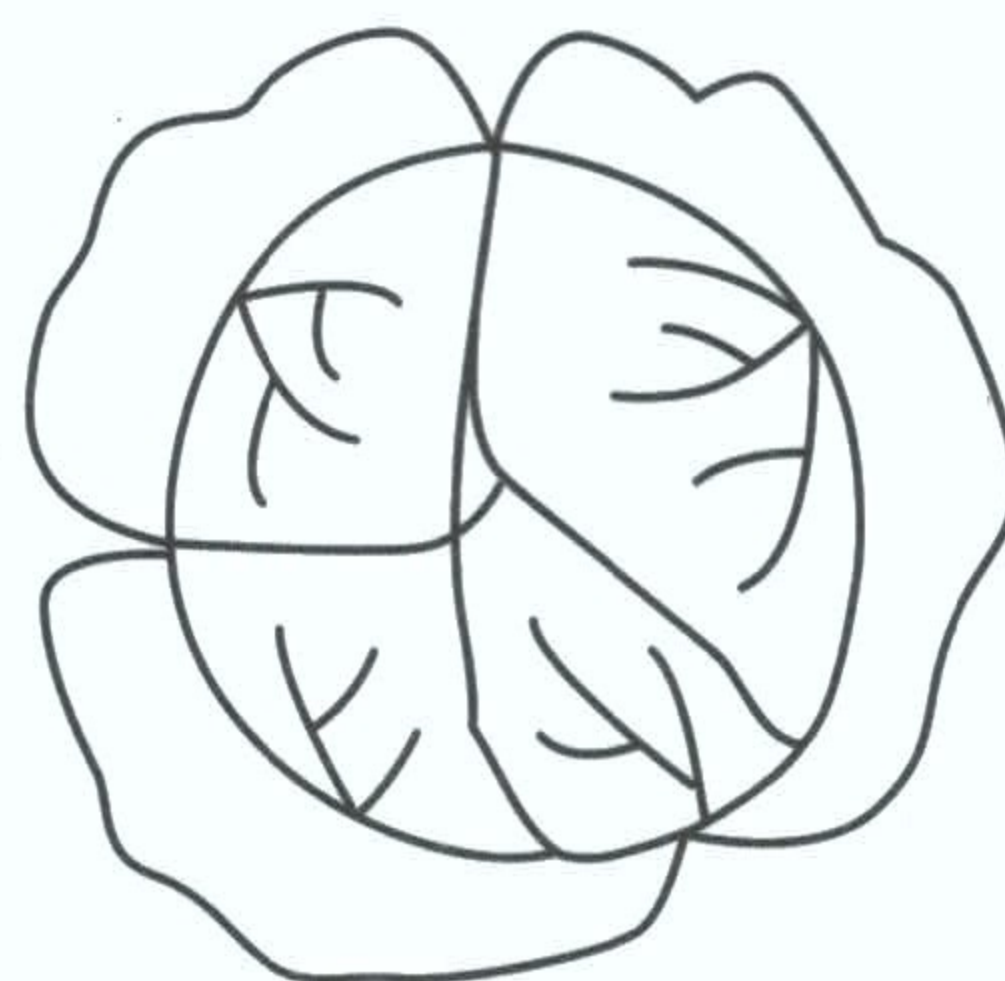
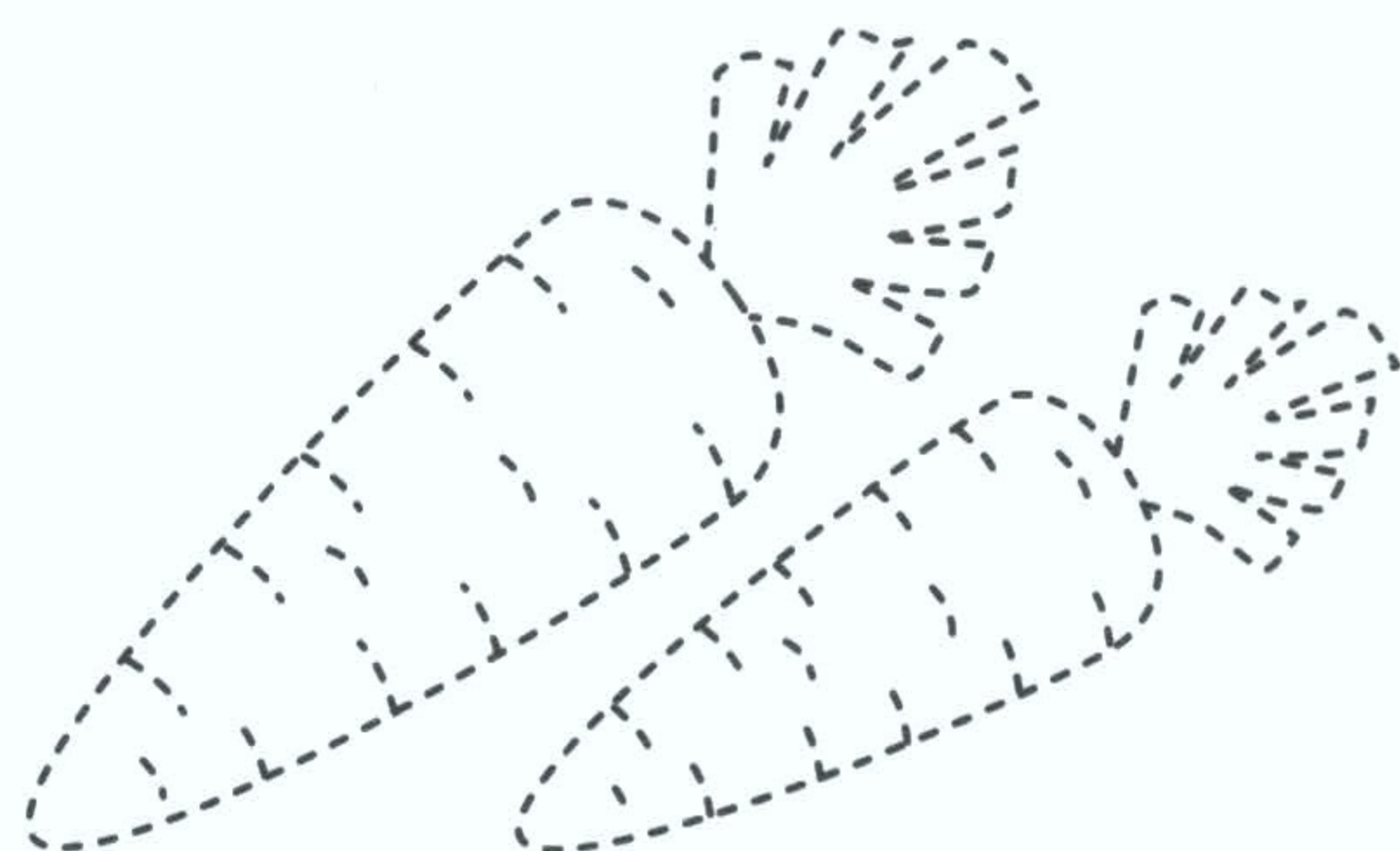
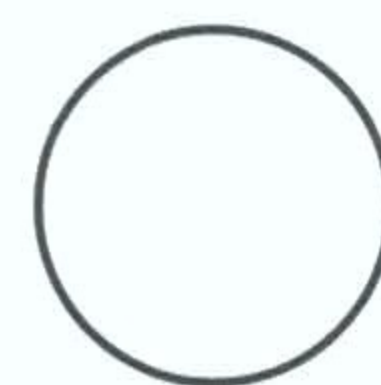
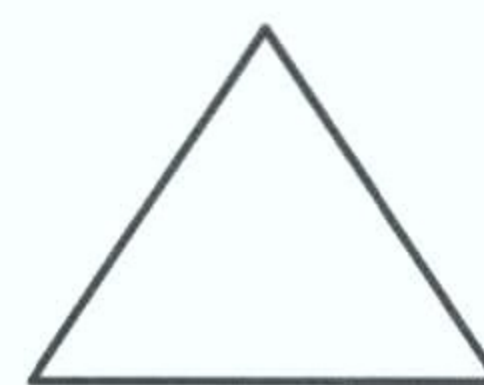
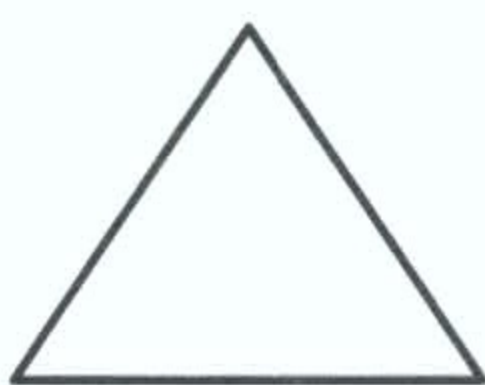
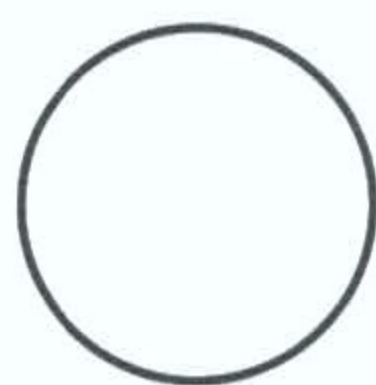
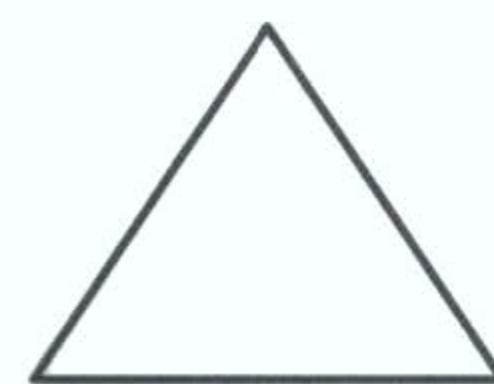
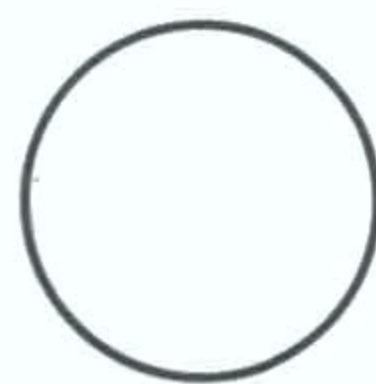
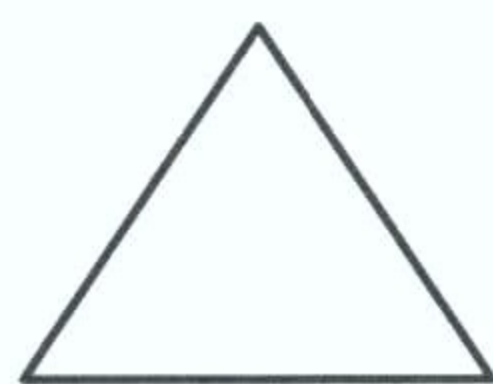
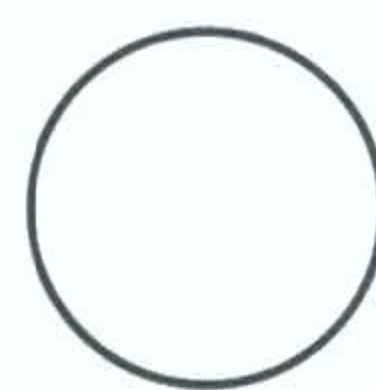
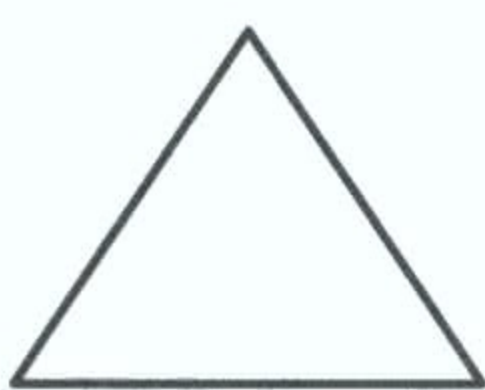
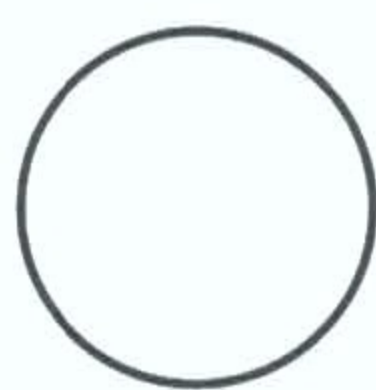

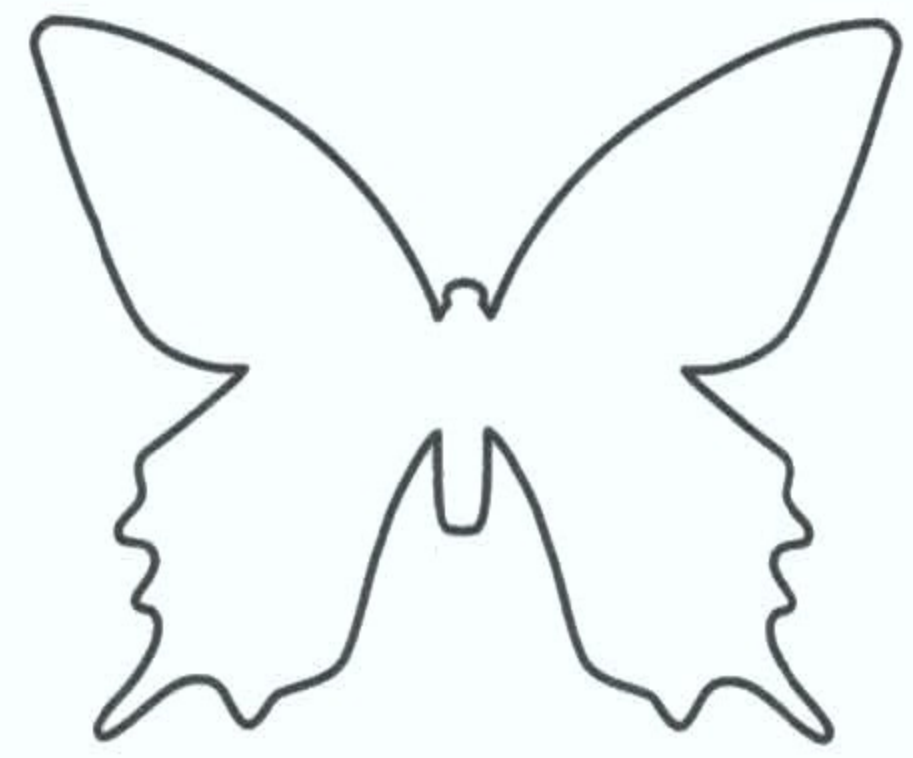
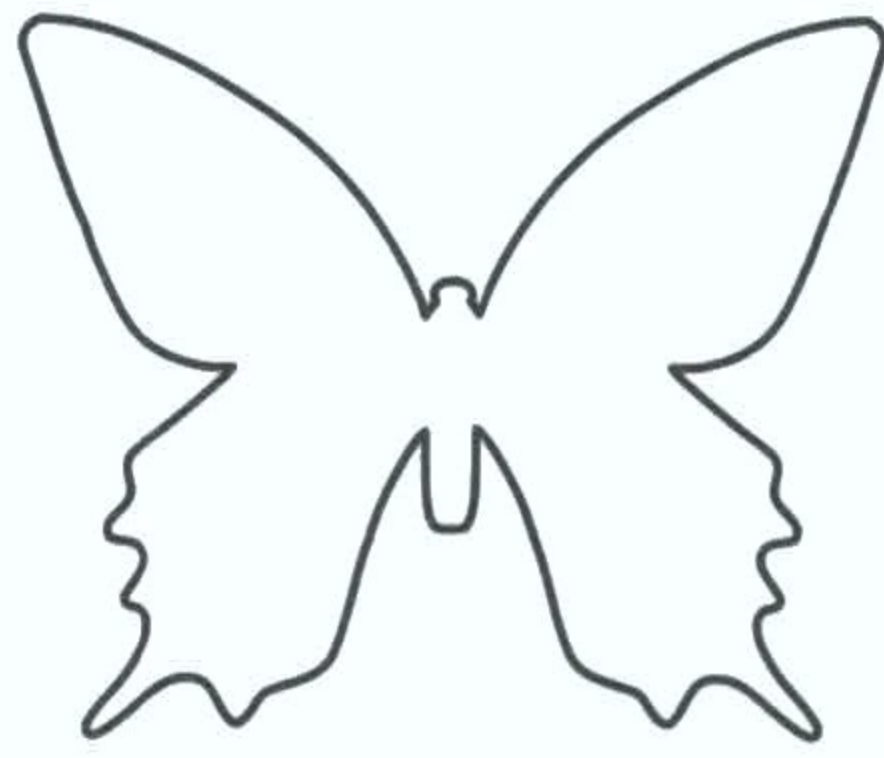

Дорисуй картинки.

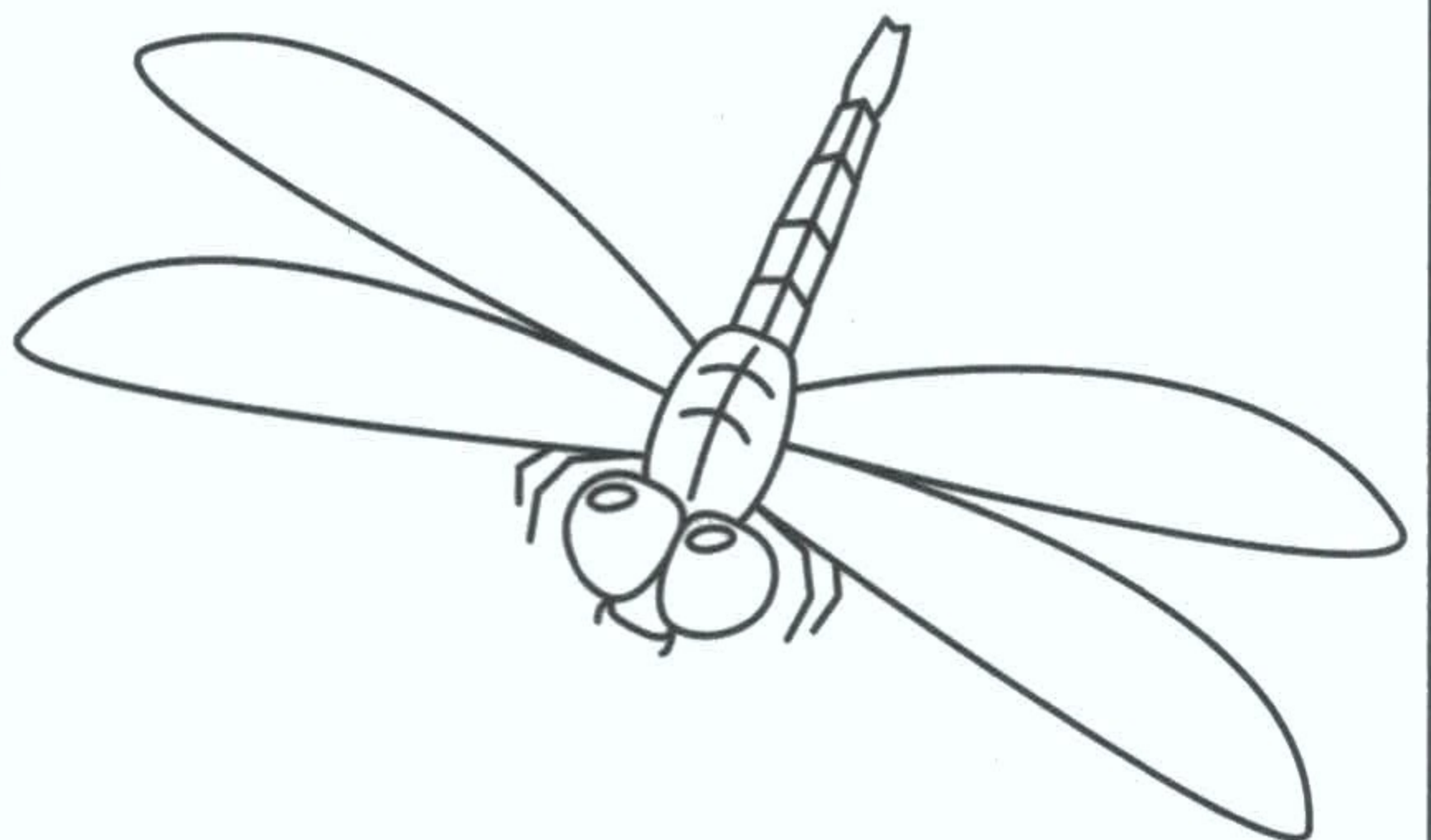
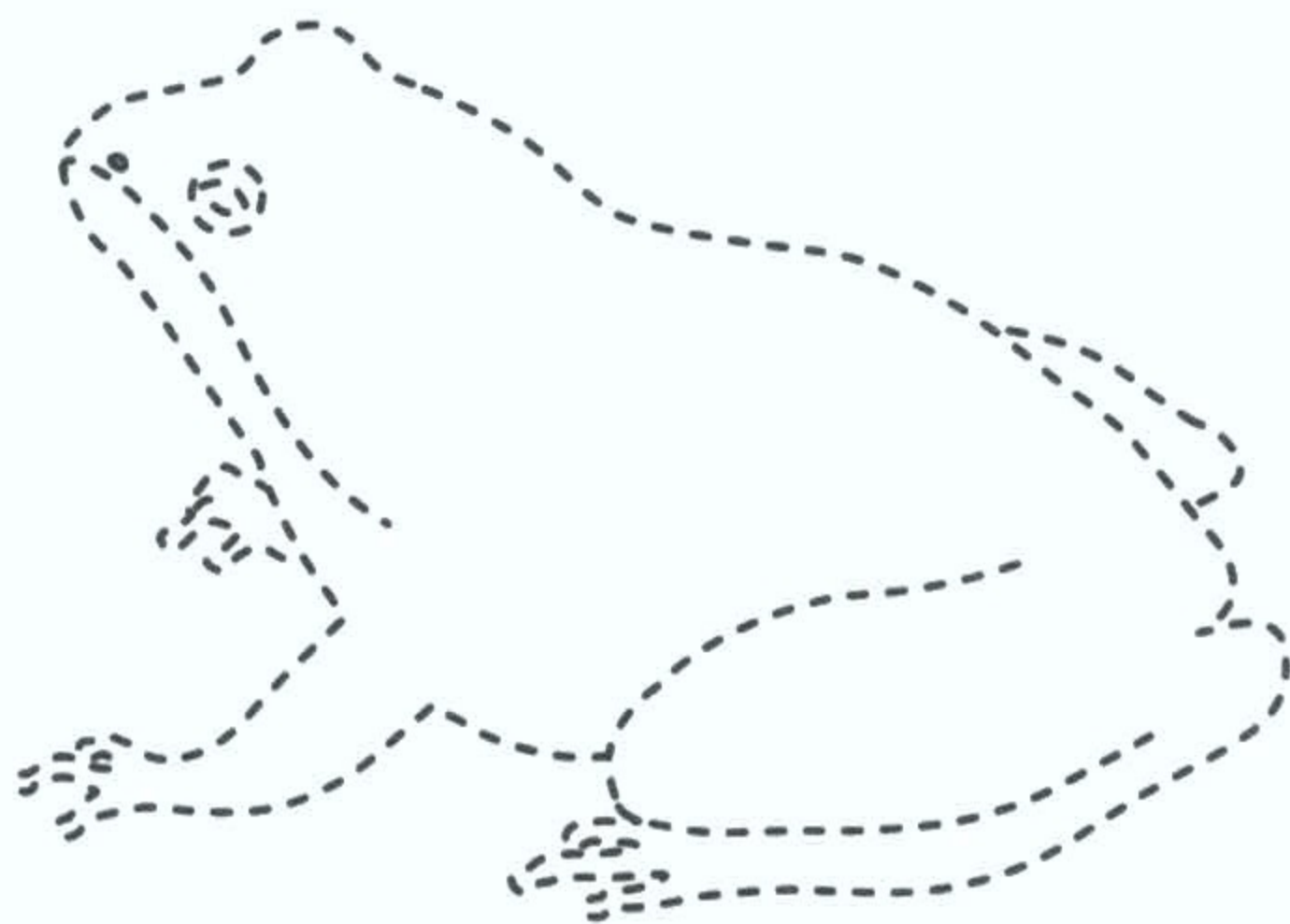
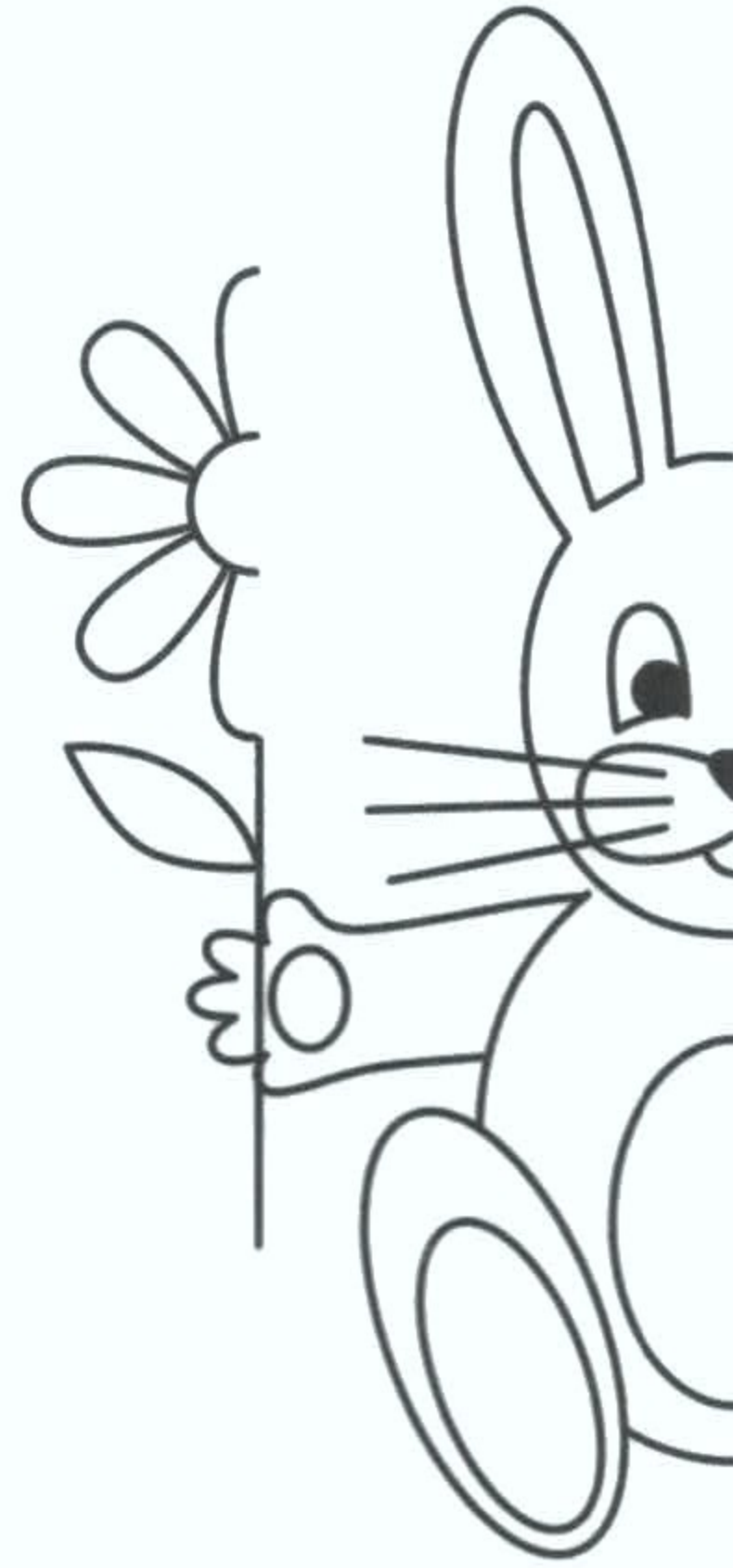
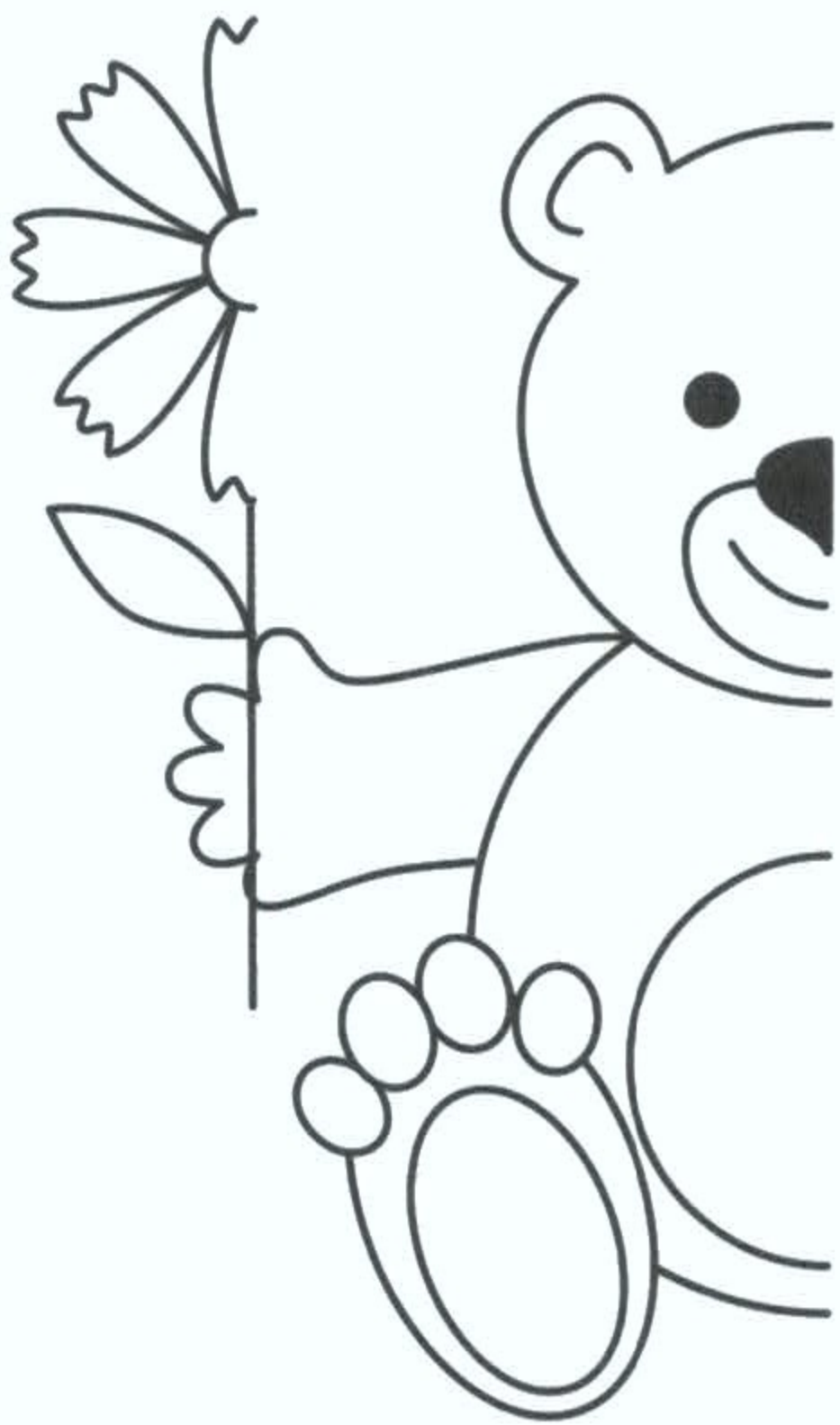



Раскрась по цифрам.



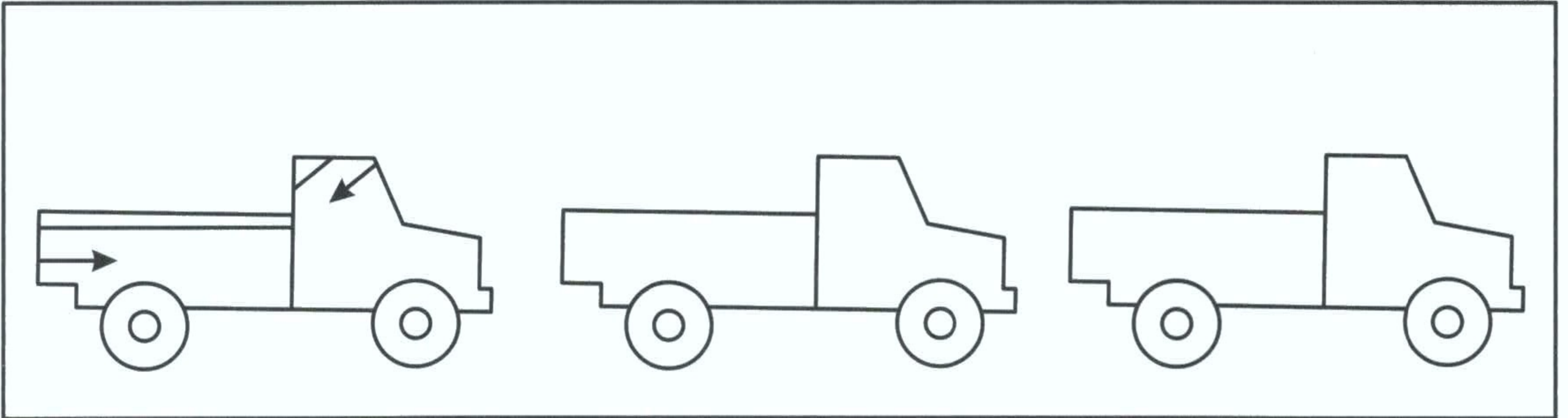

Раскрась на рисунке только детали с точками.
Что получилось?

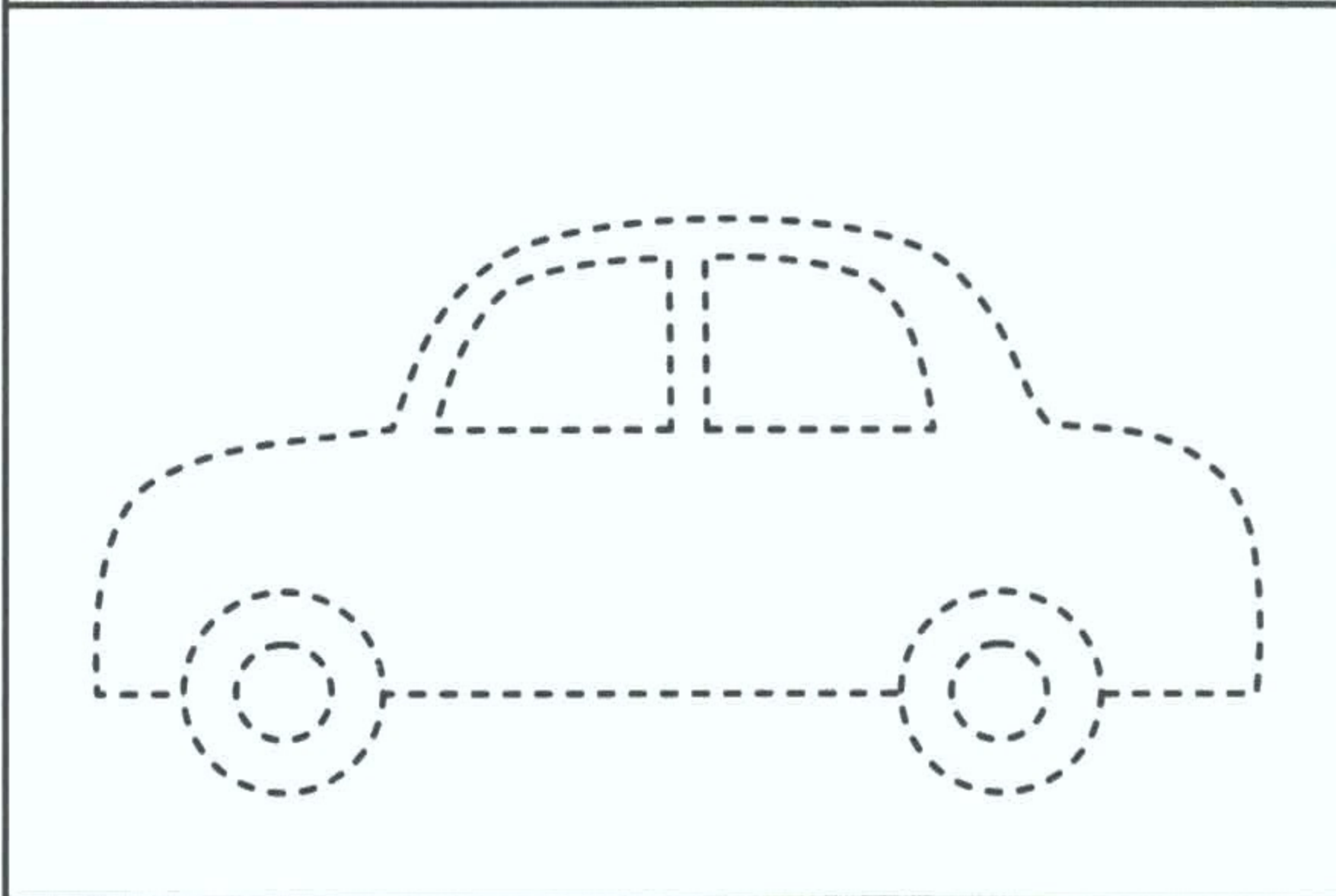
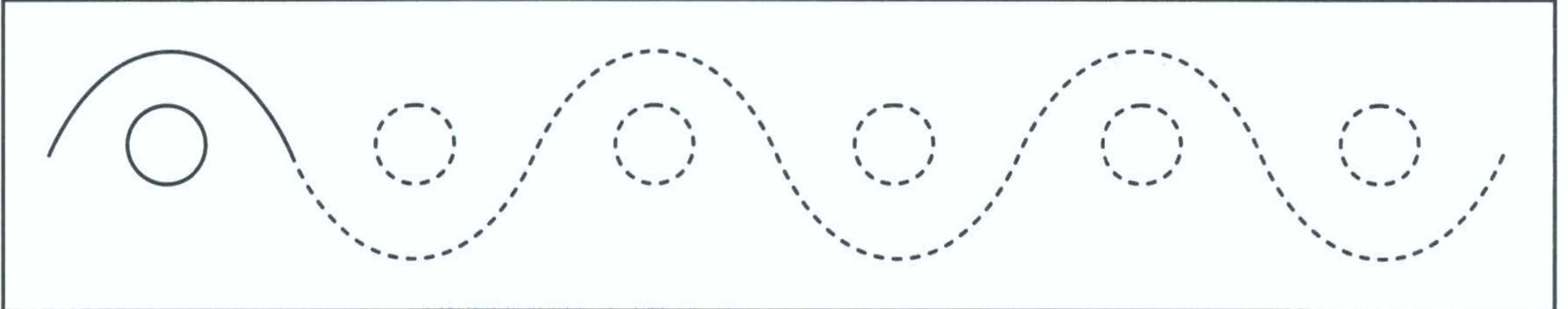
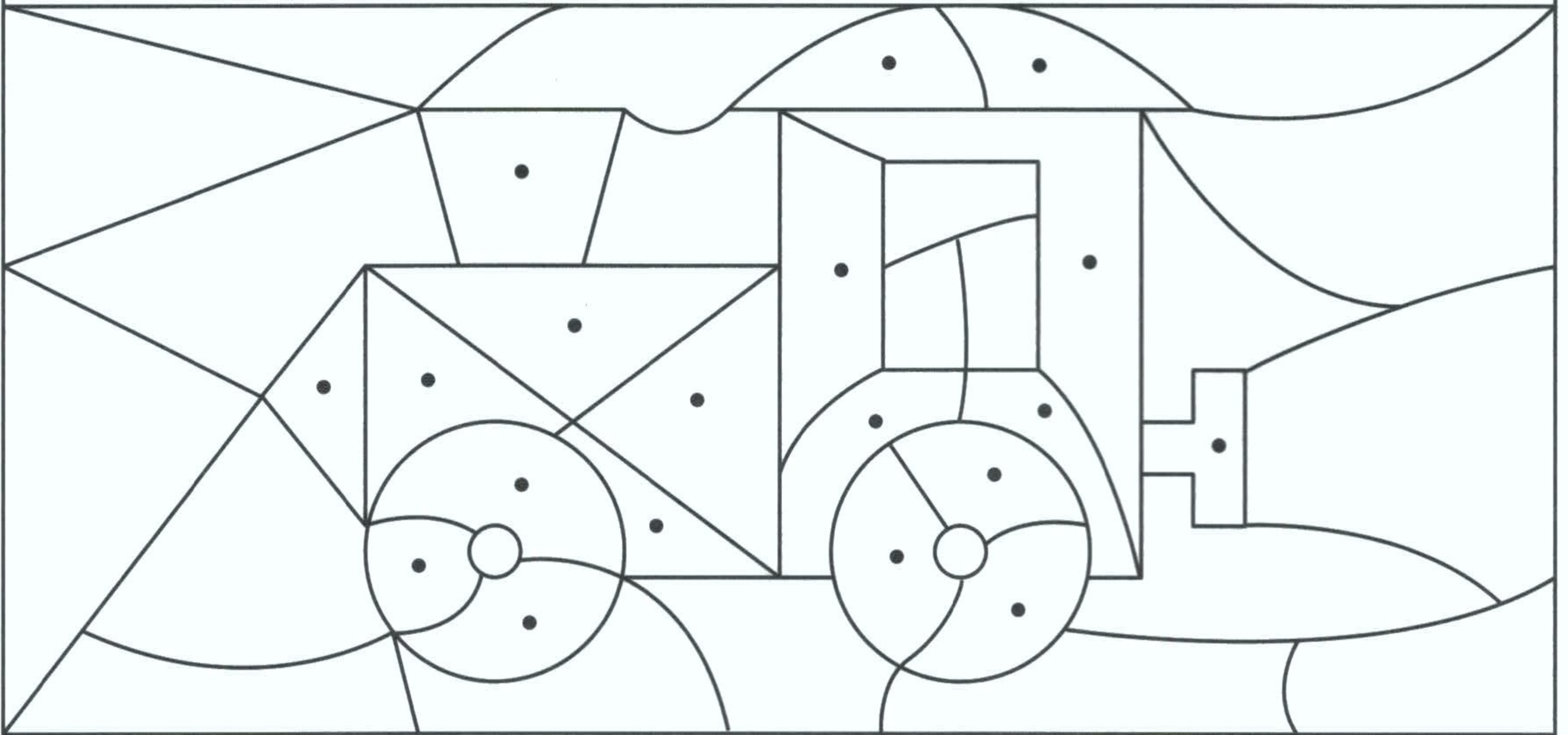

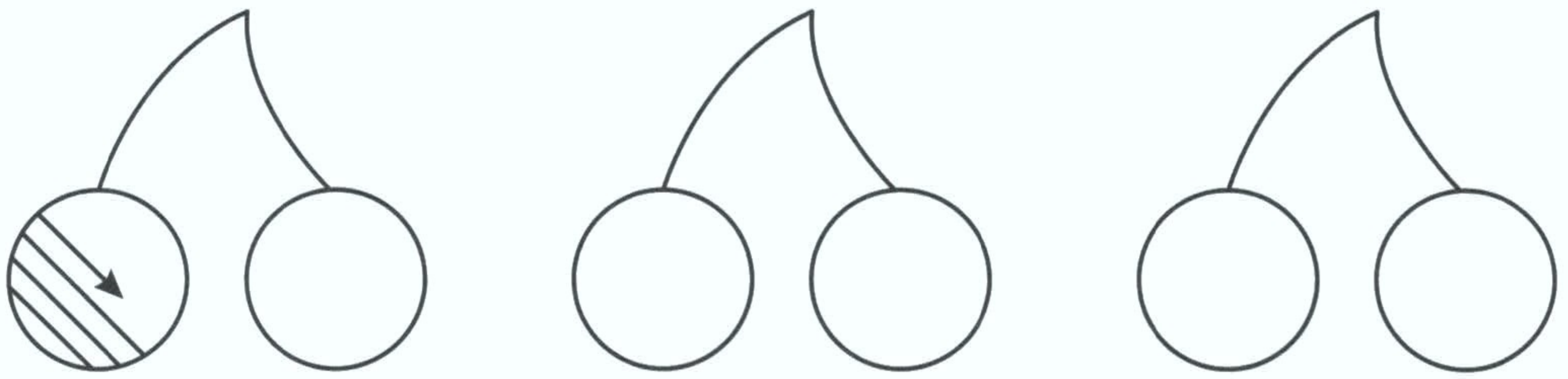

Нарисуй рядом такой же точно рисунок по точкам.

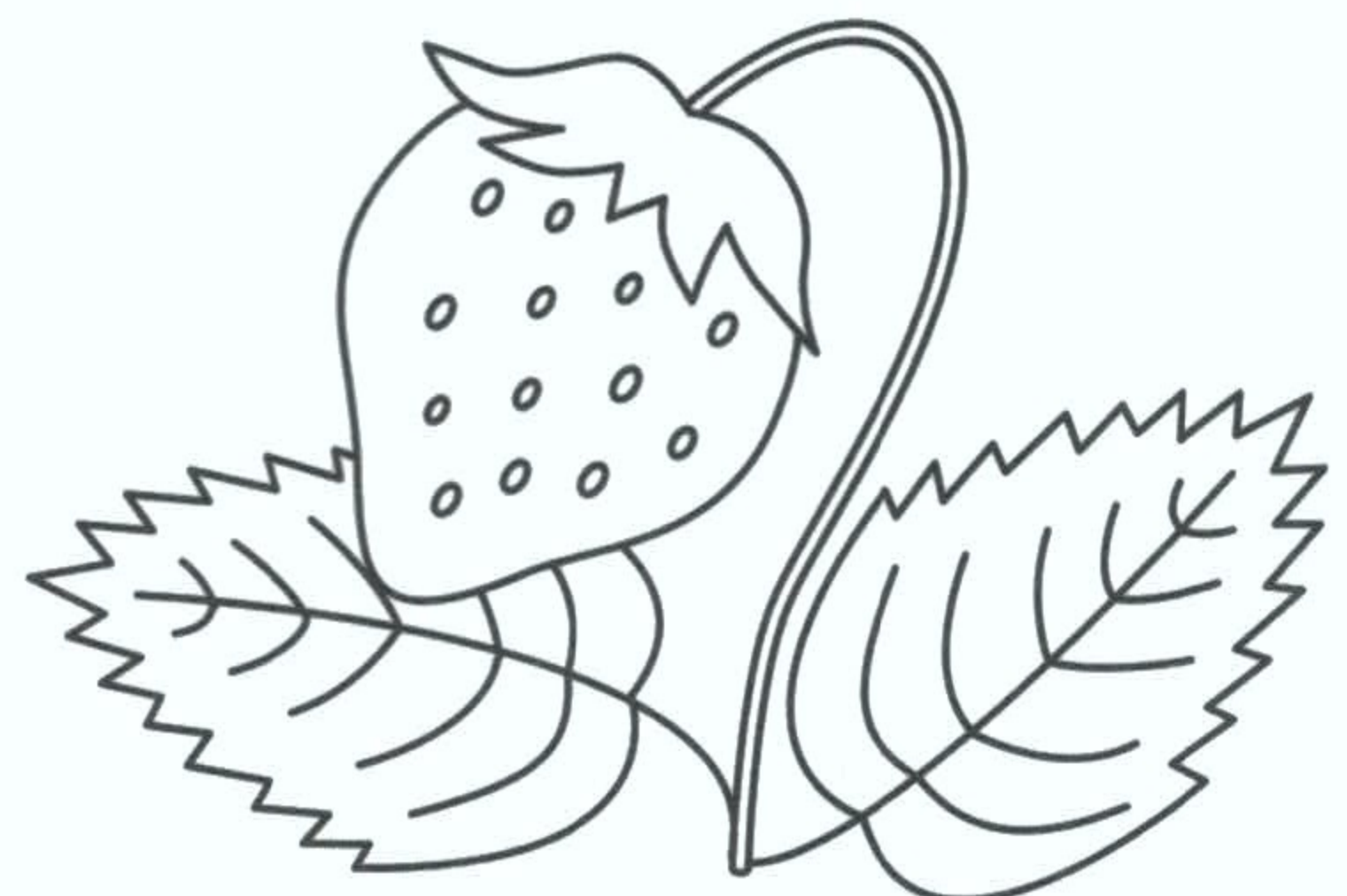
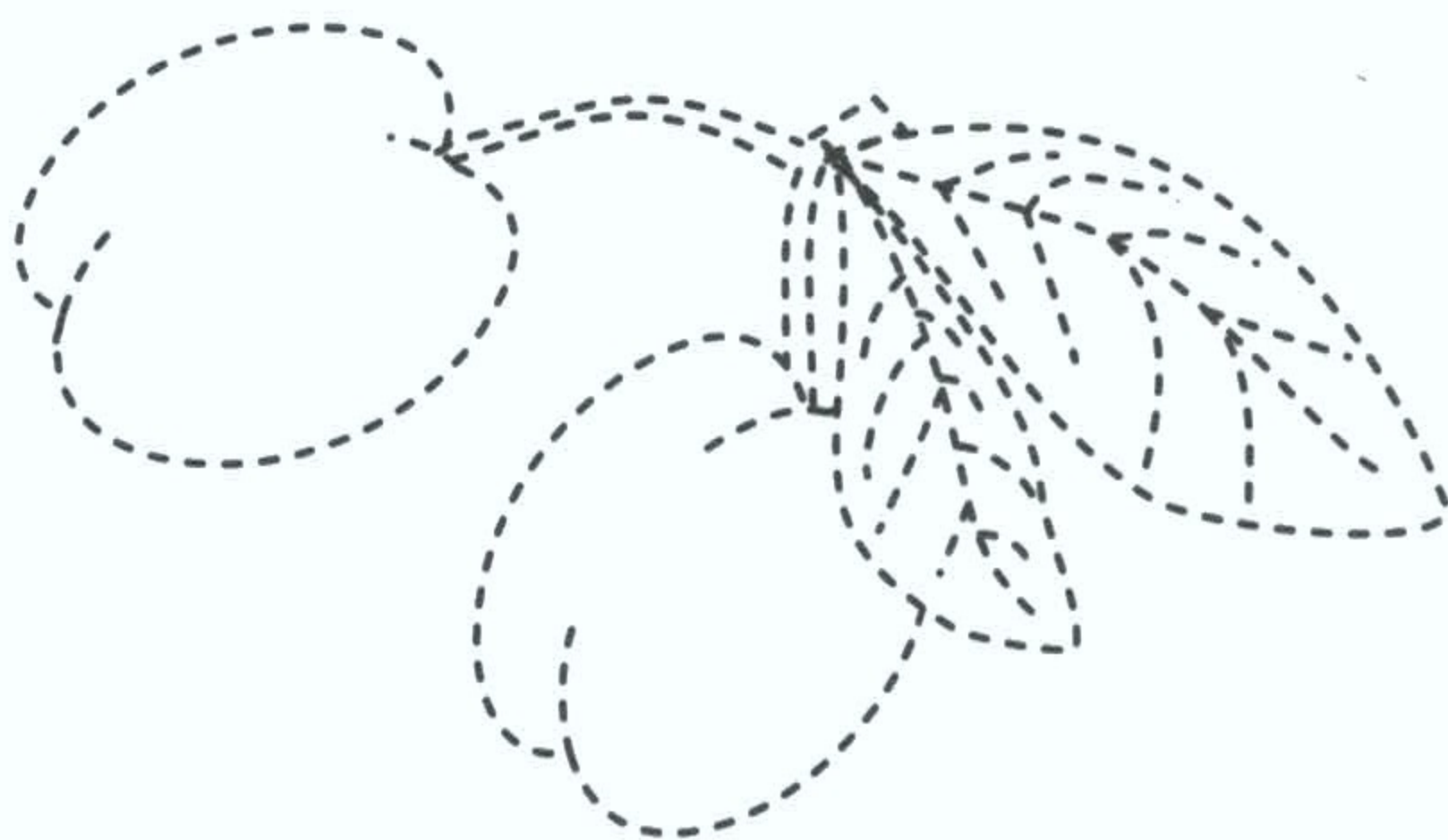
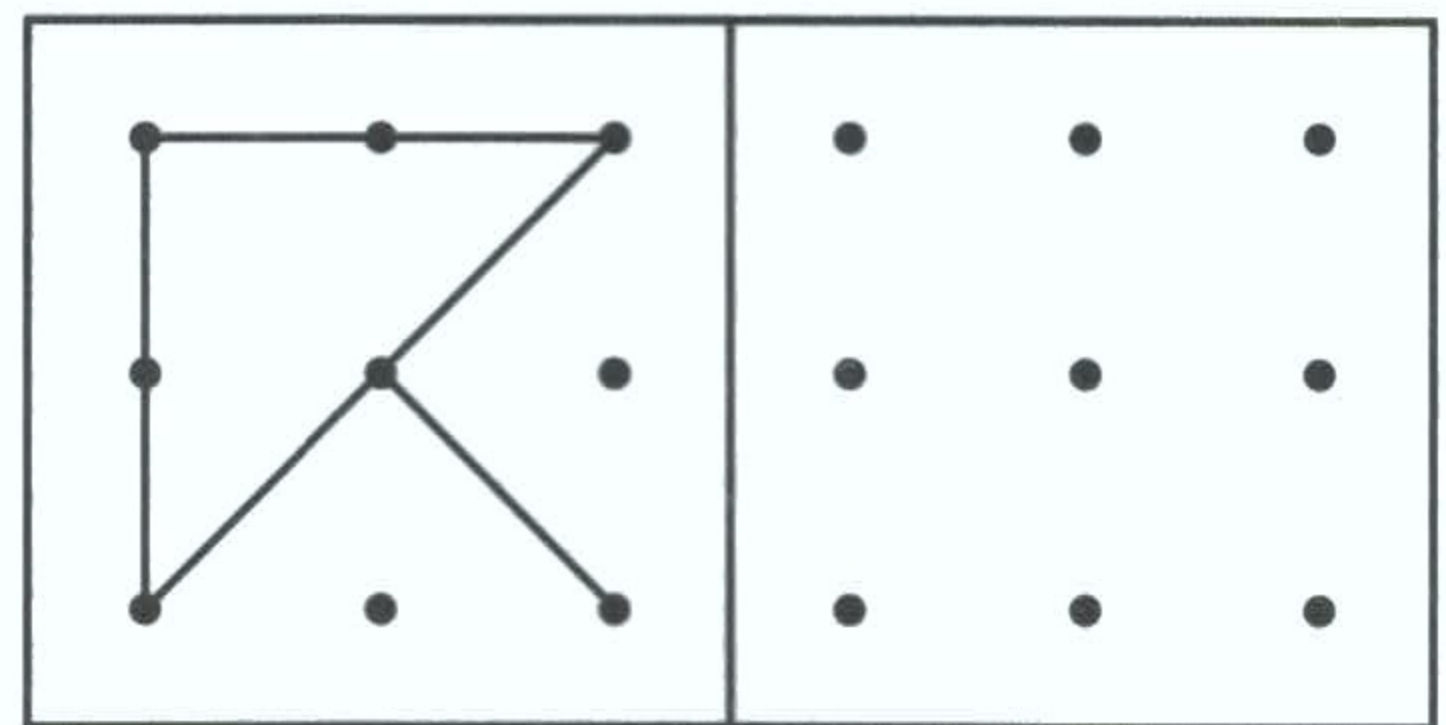
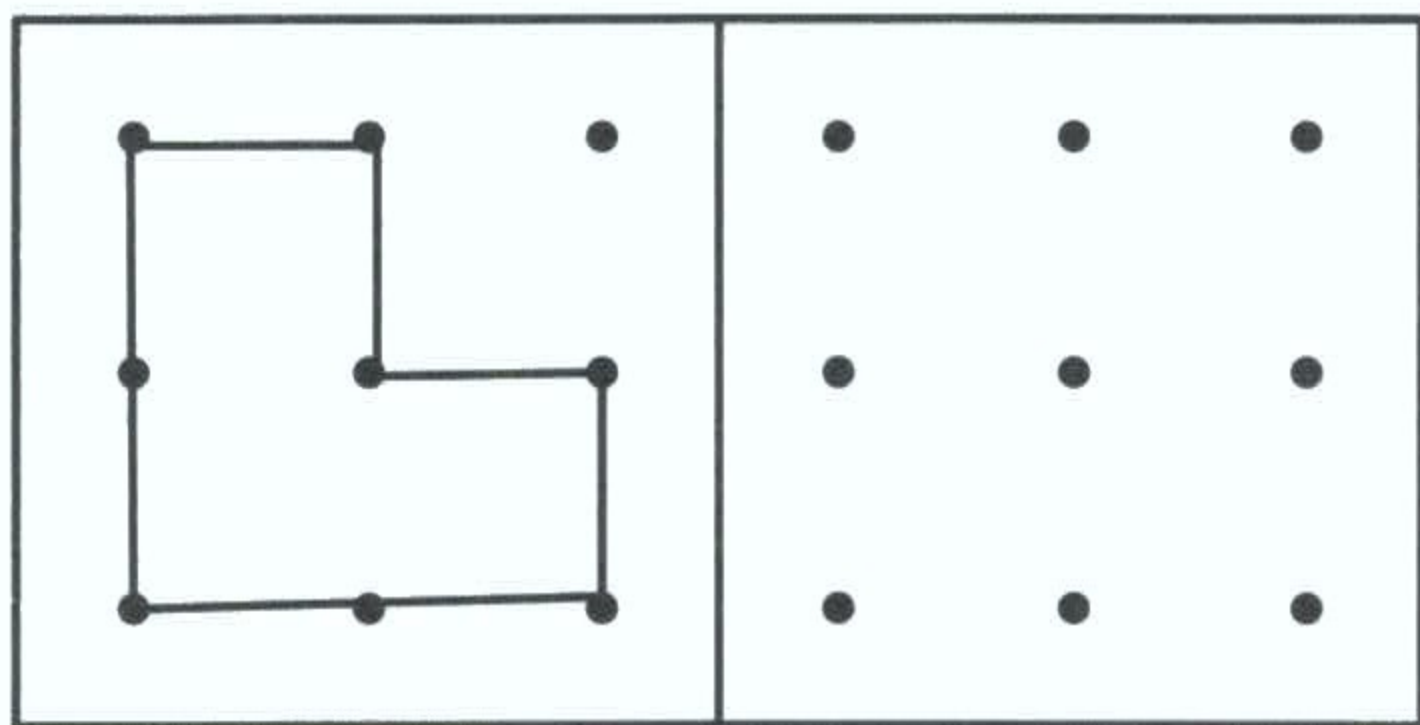
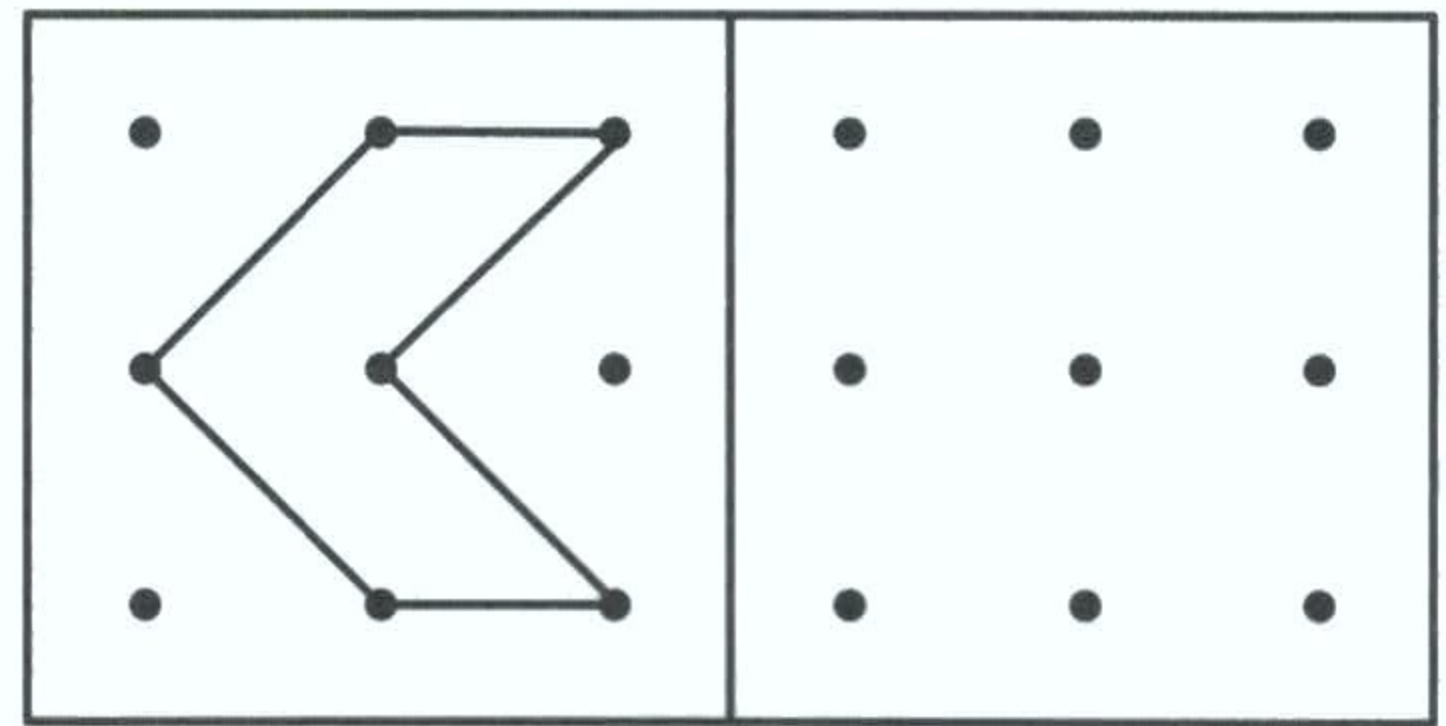
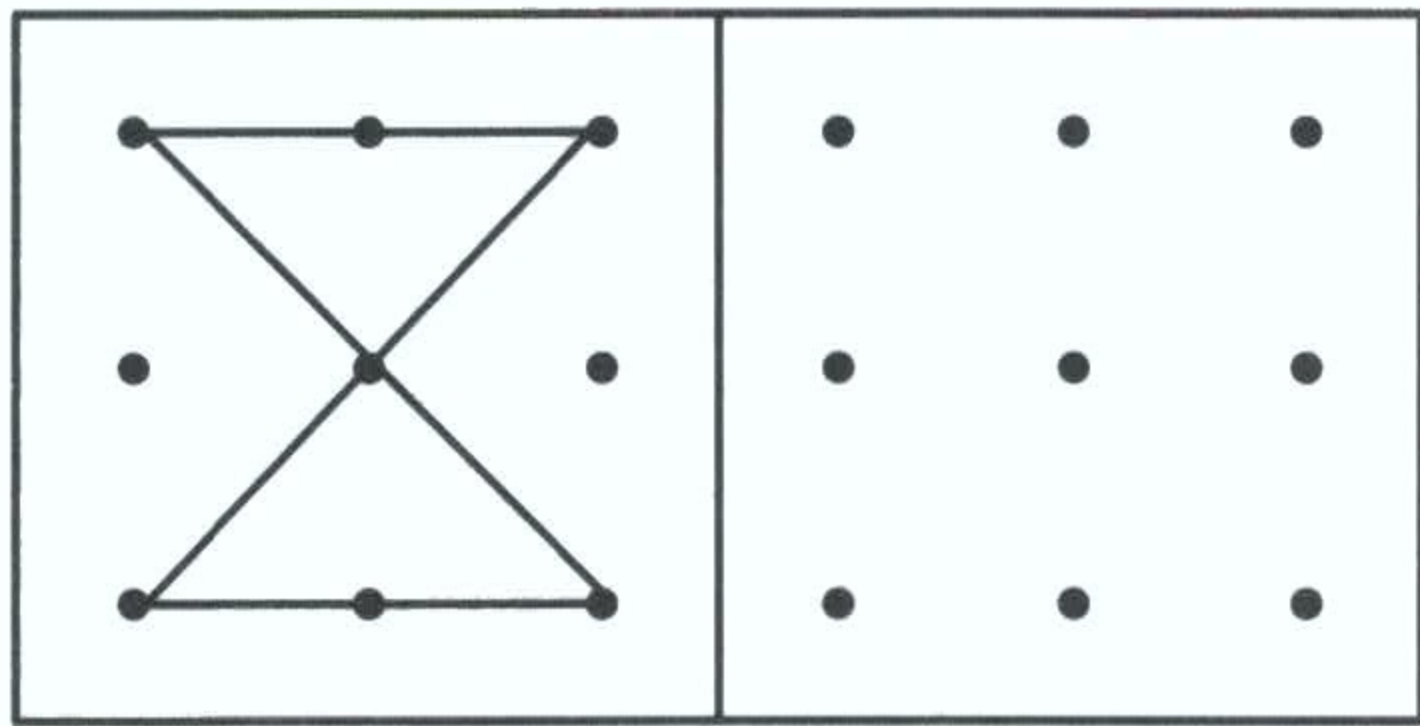

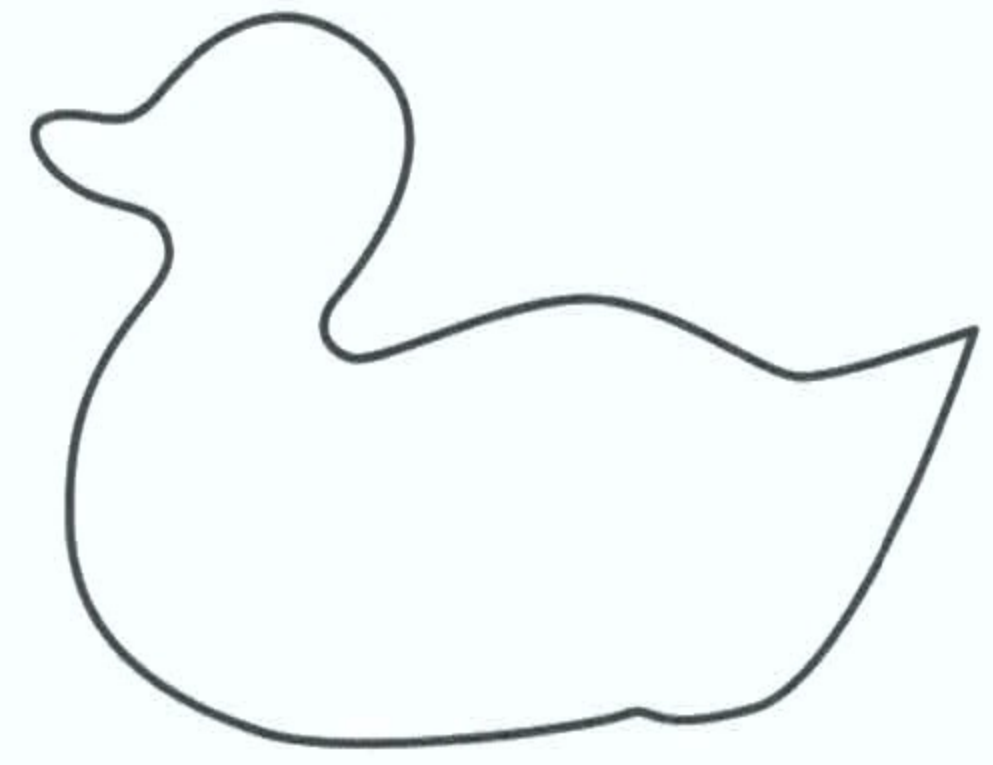
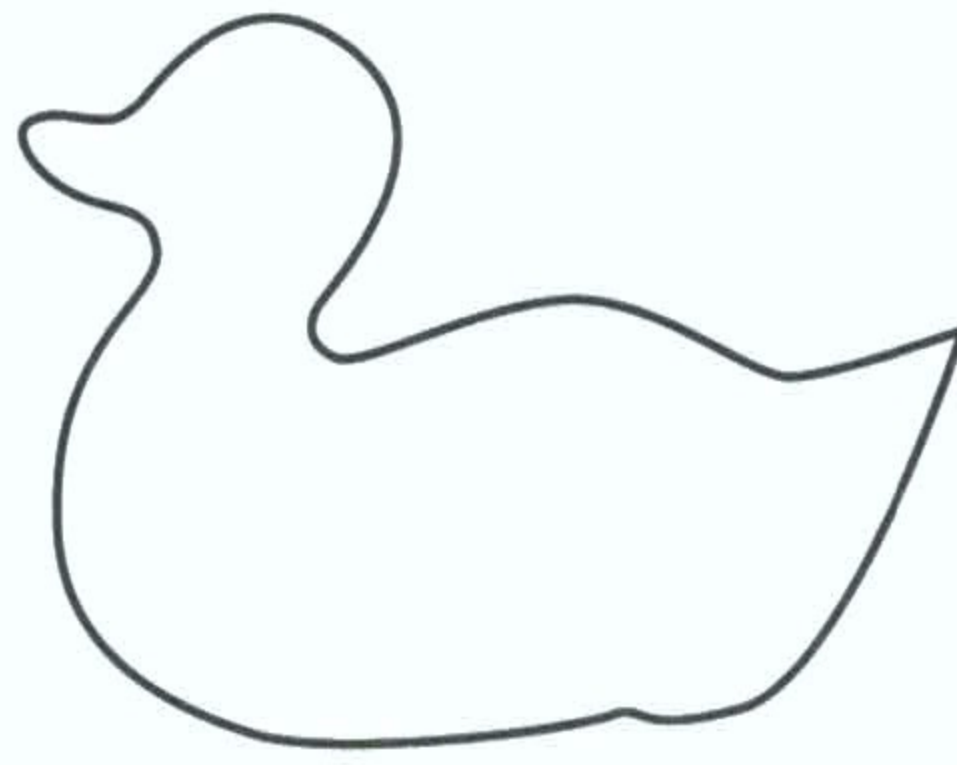
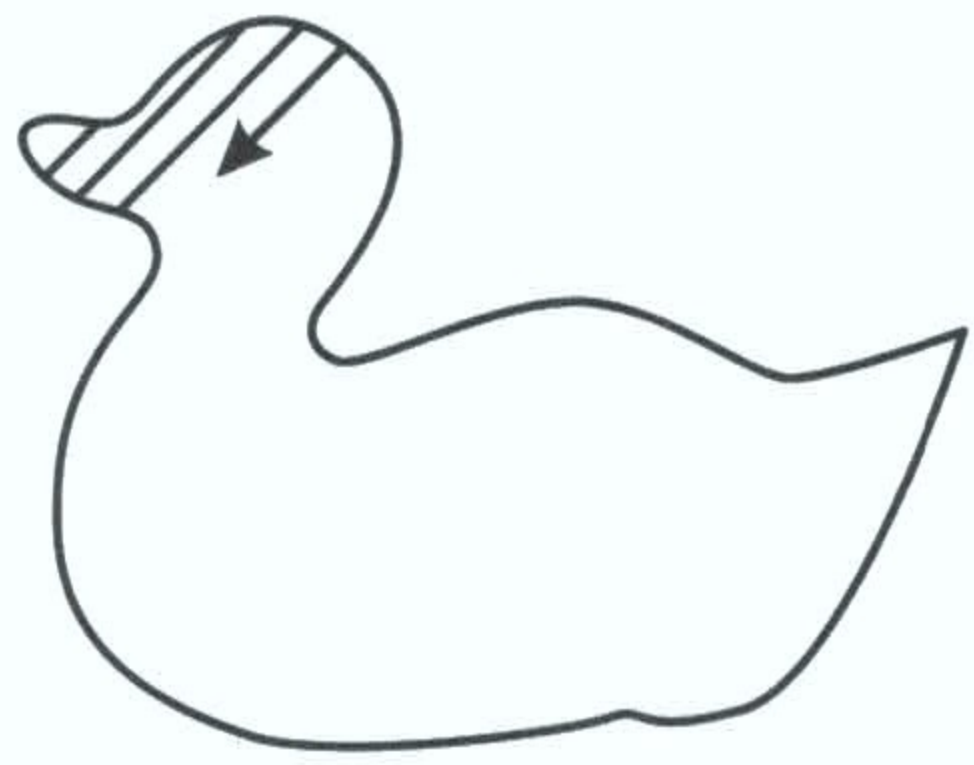

Дорисуй картинки.

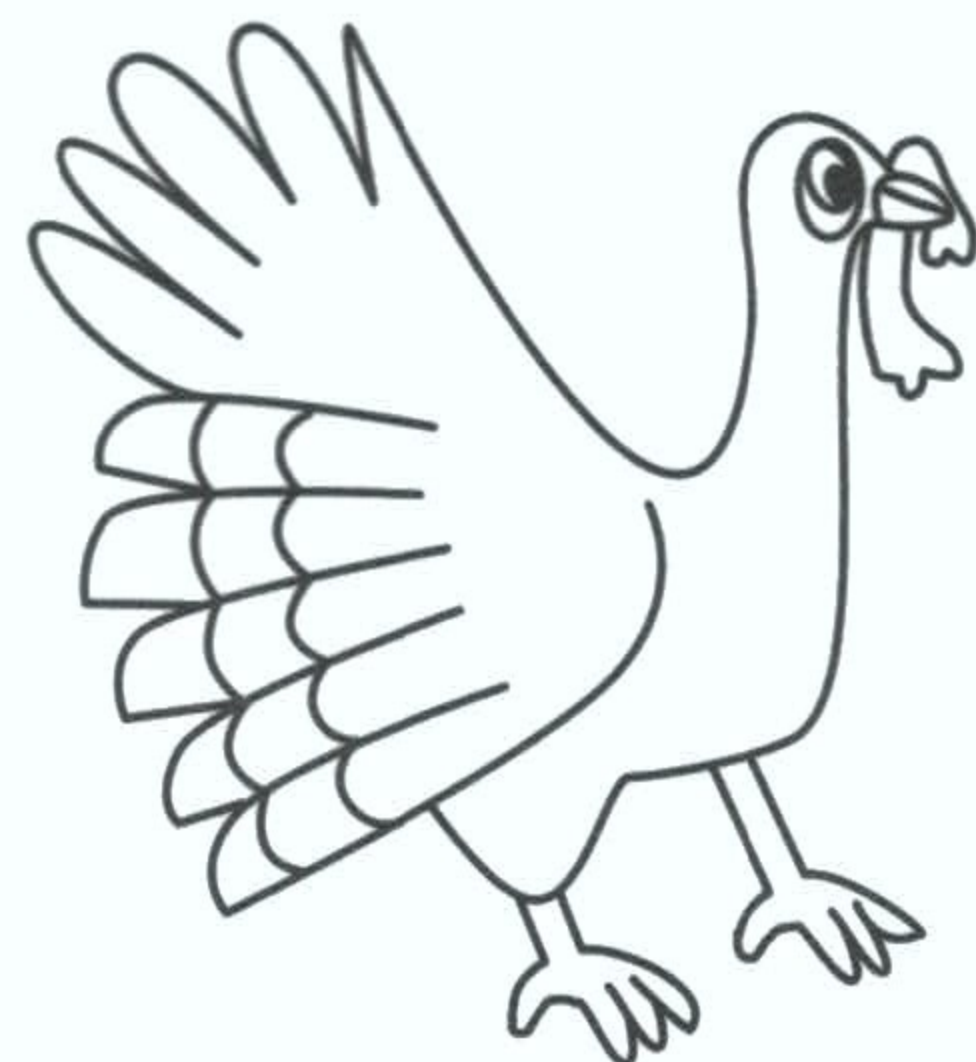
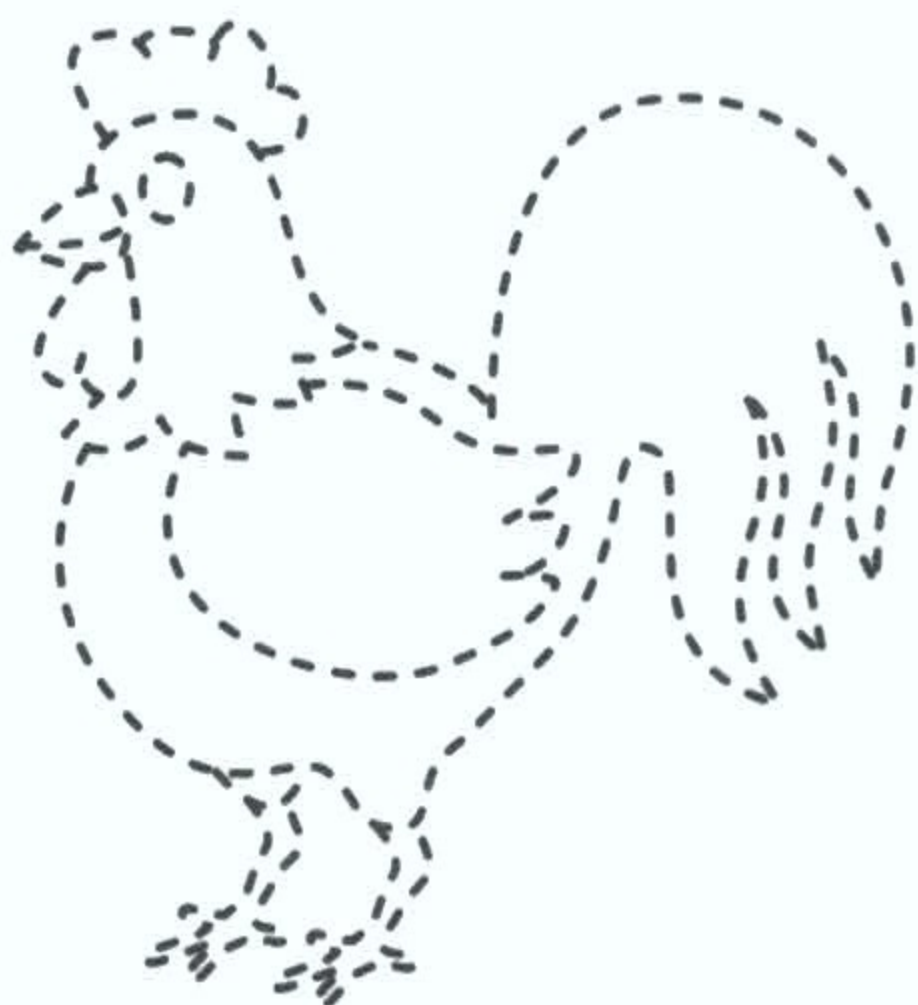
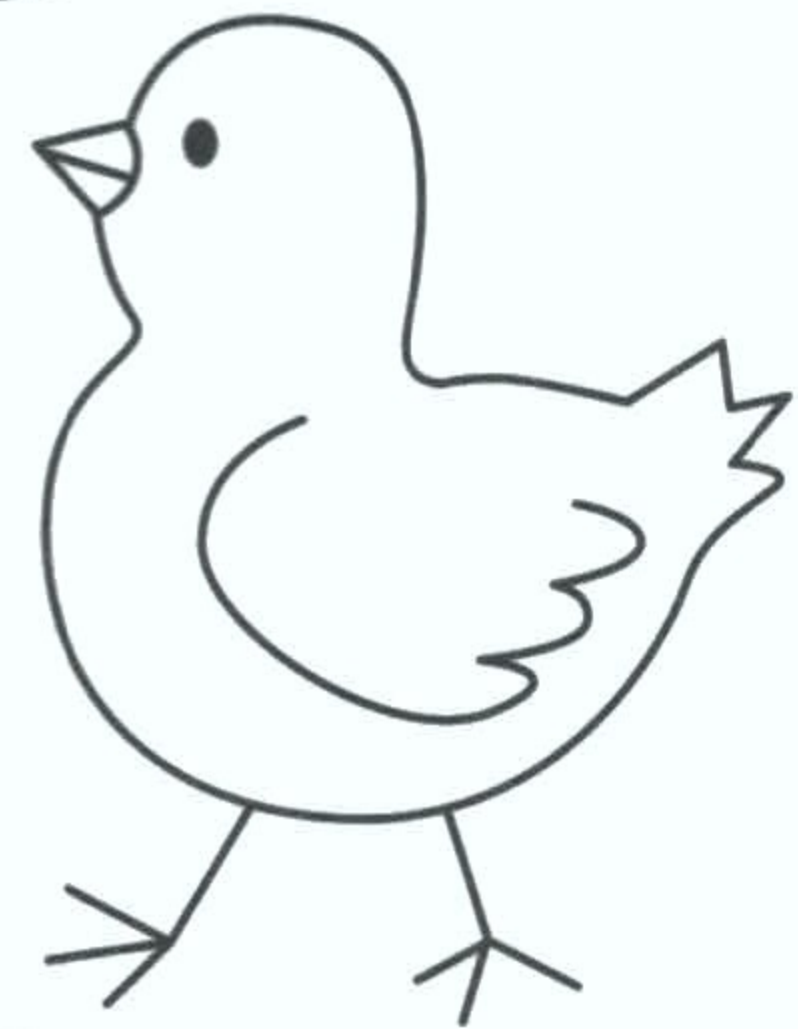
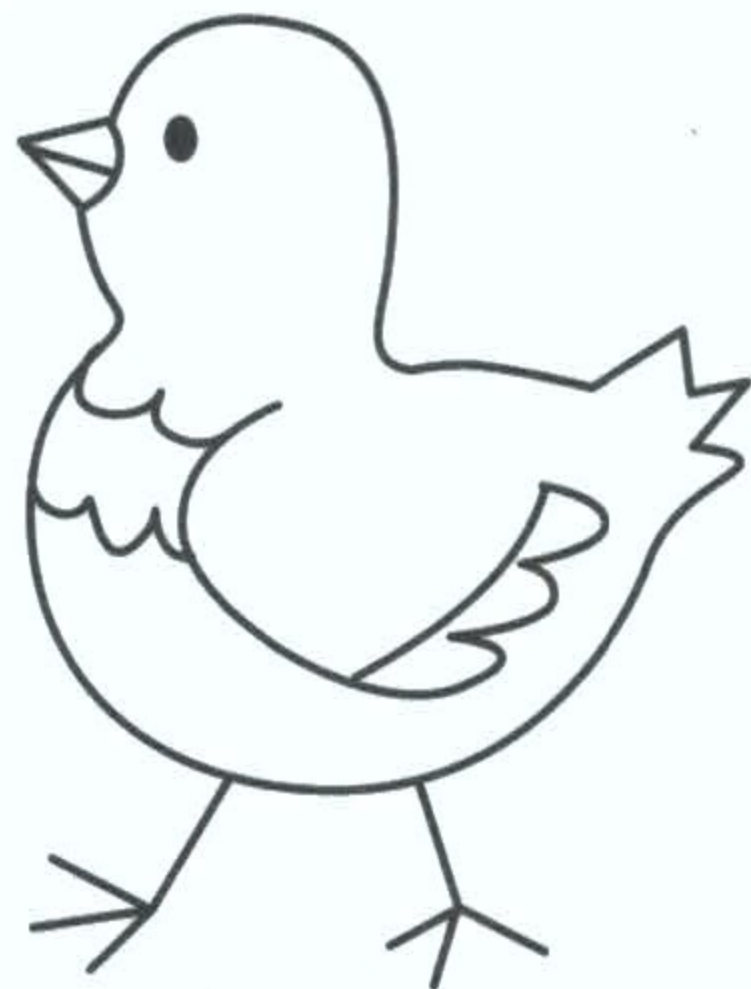
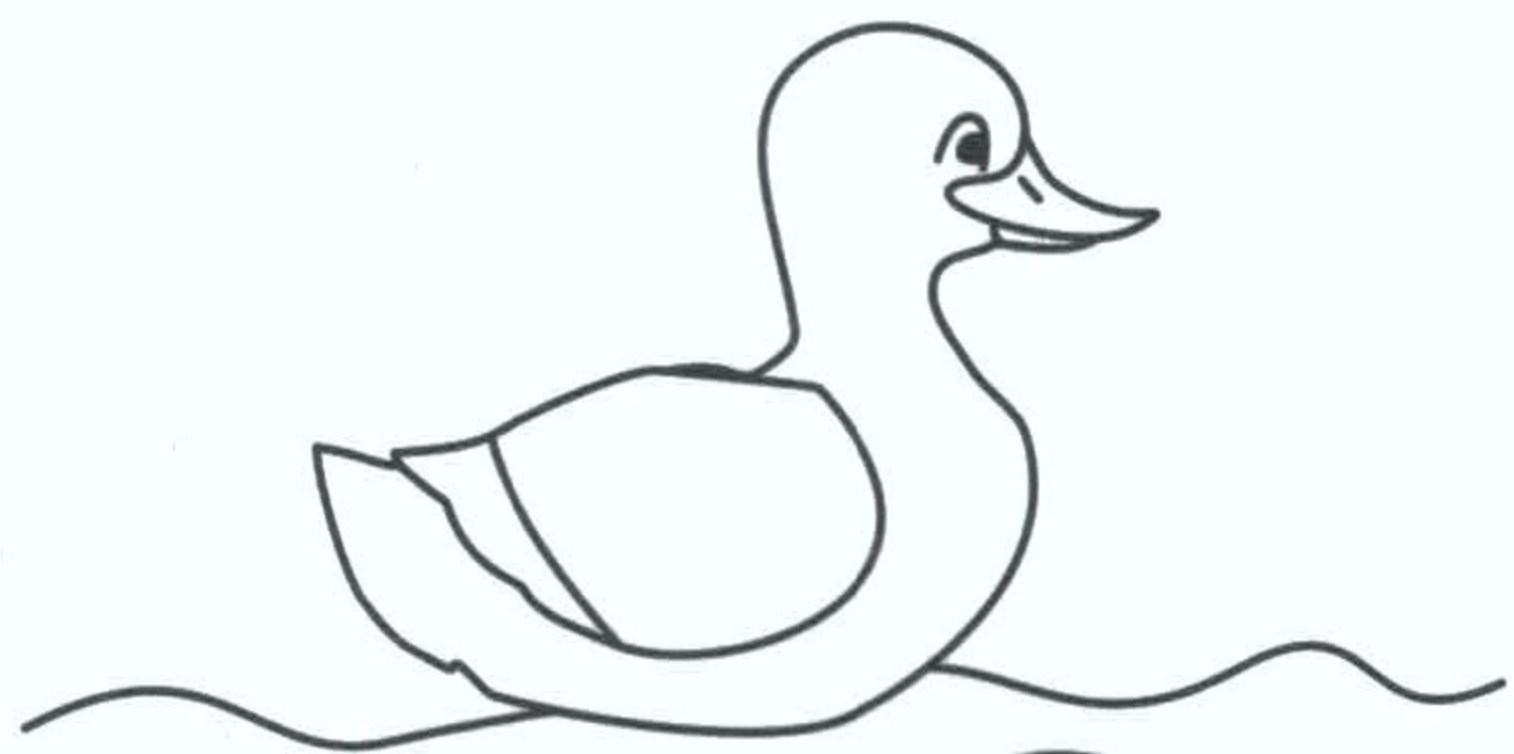
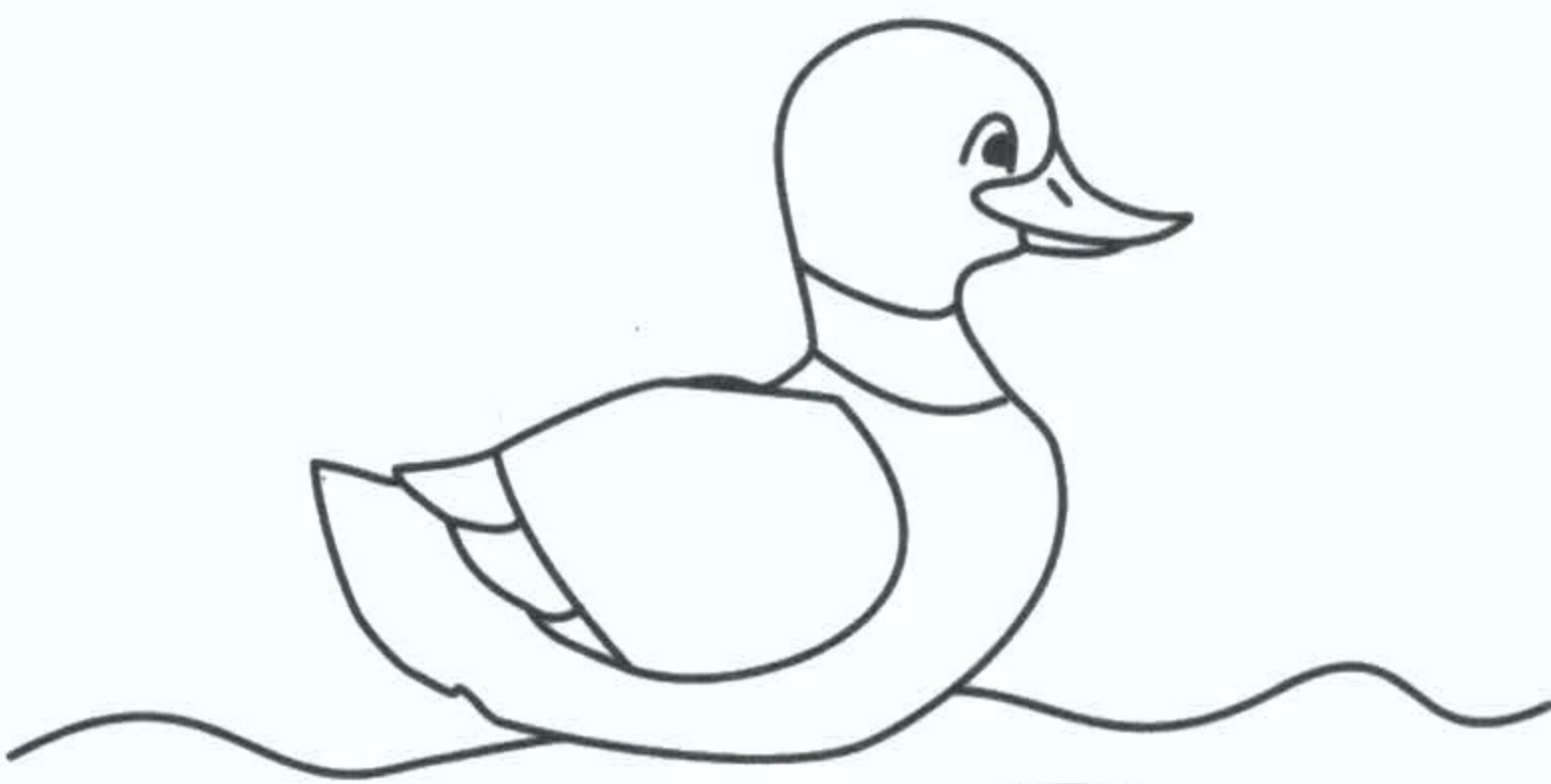

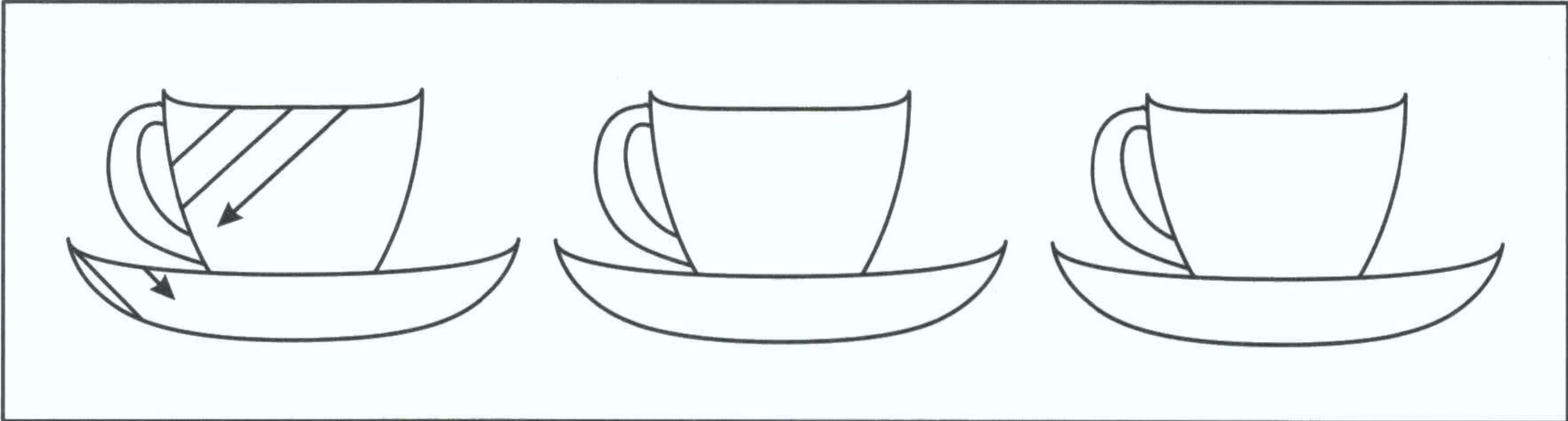

Нарисуй справа точно такой же рисунок.

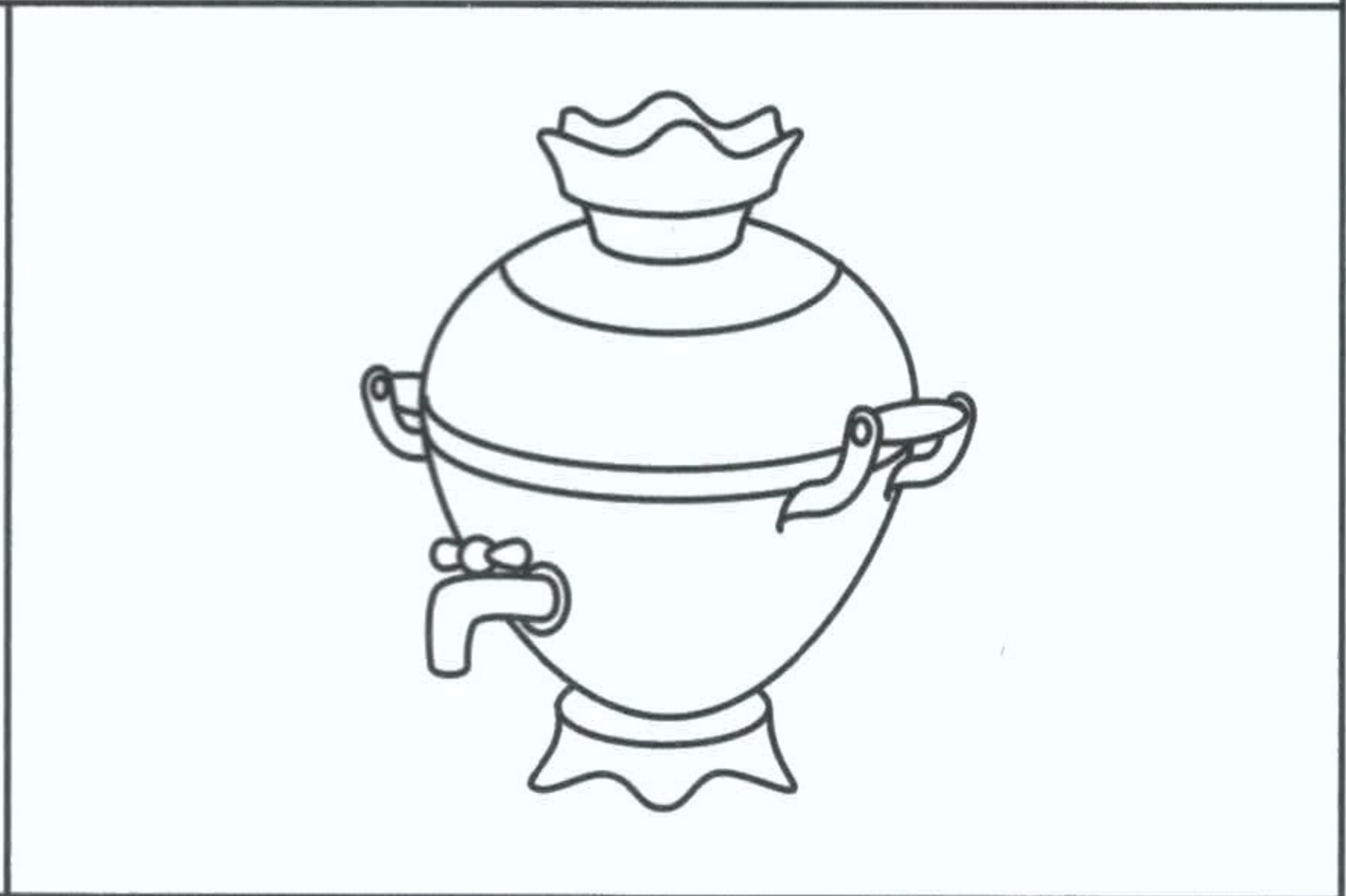
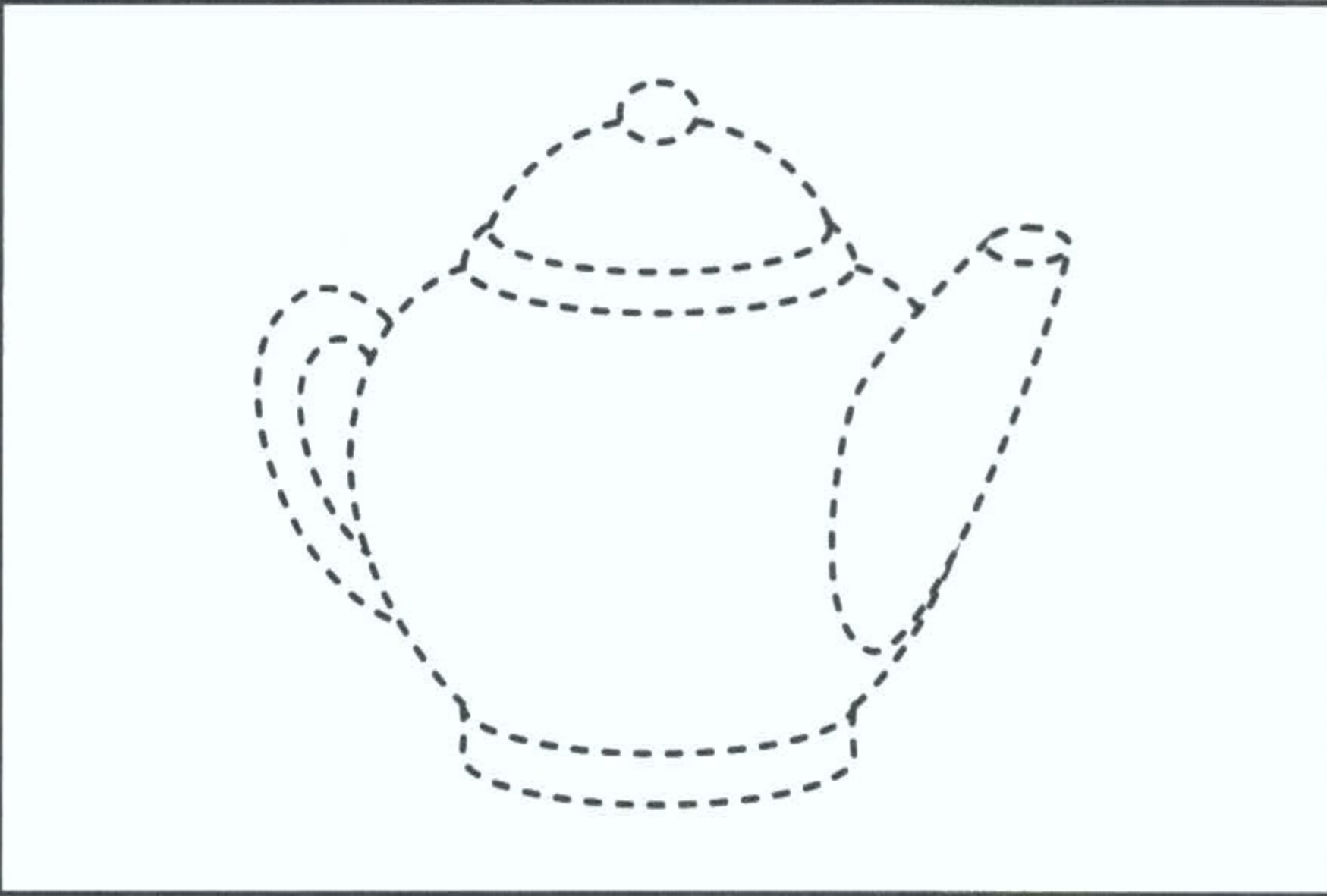
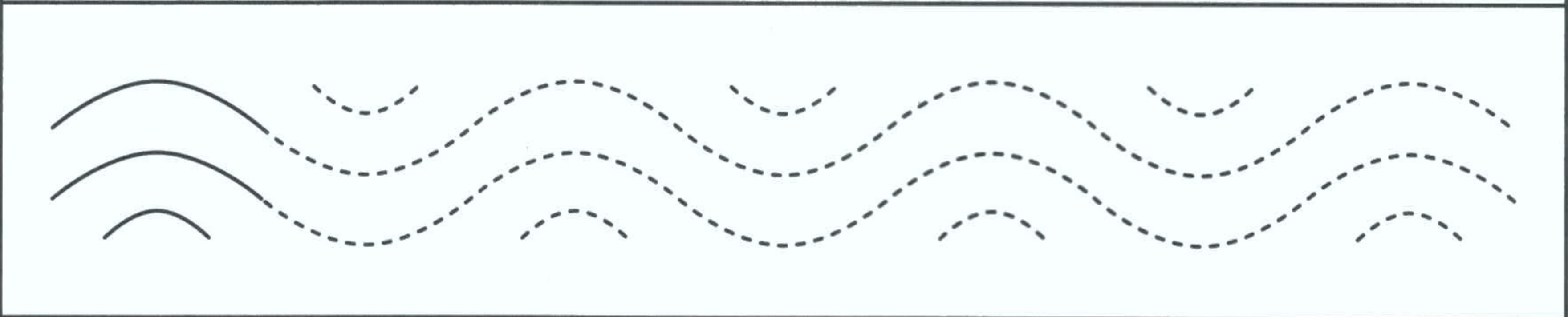
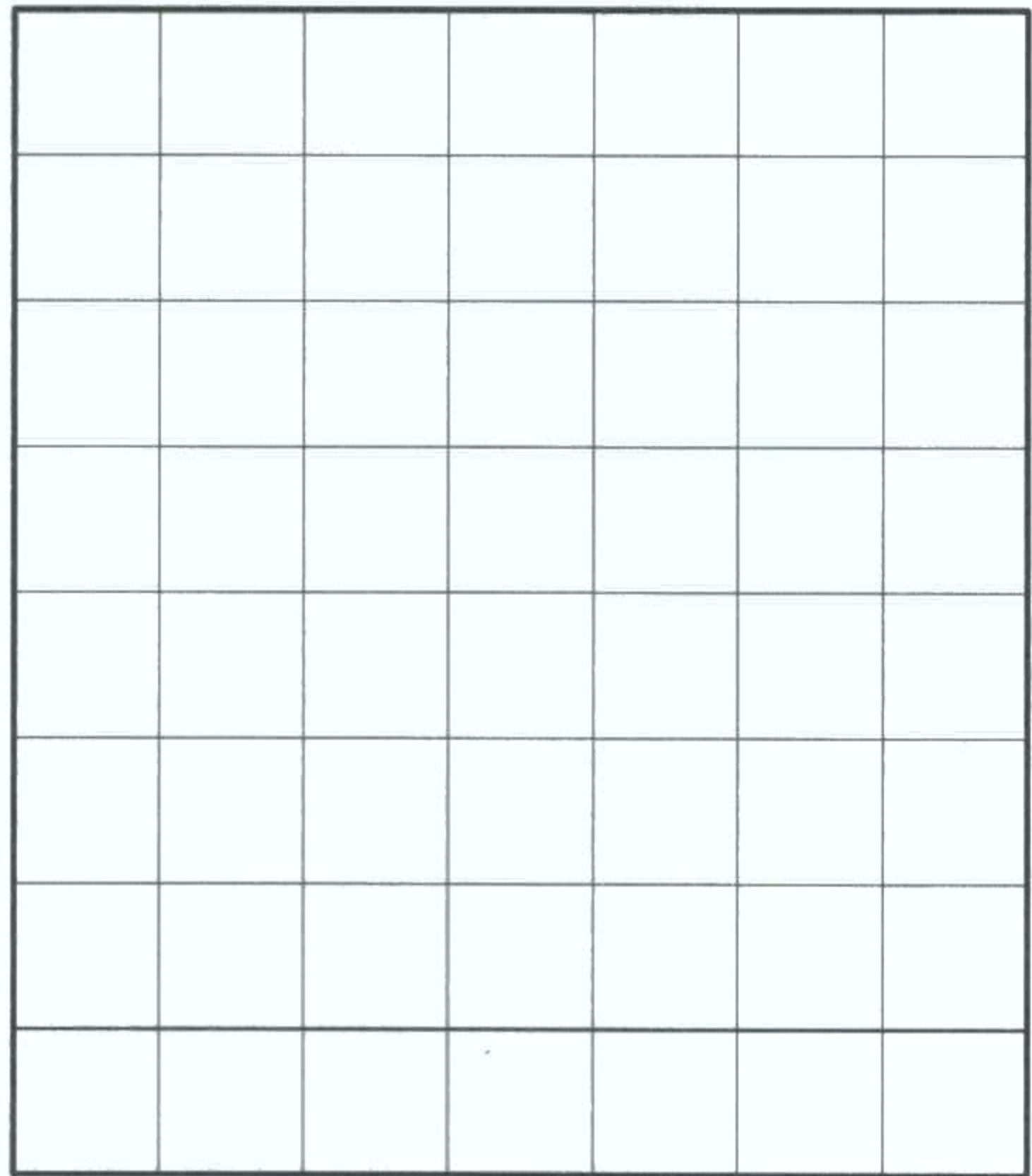
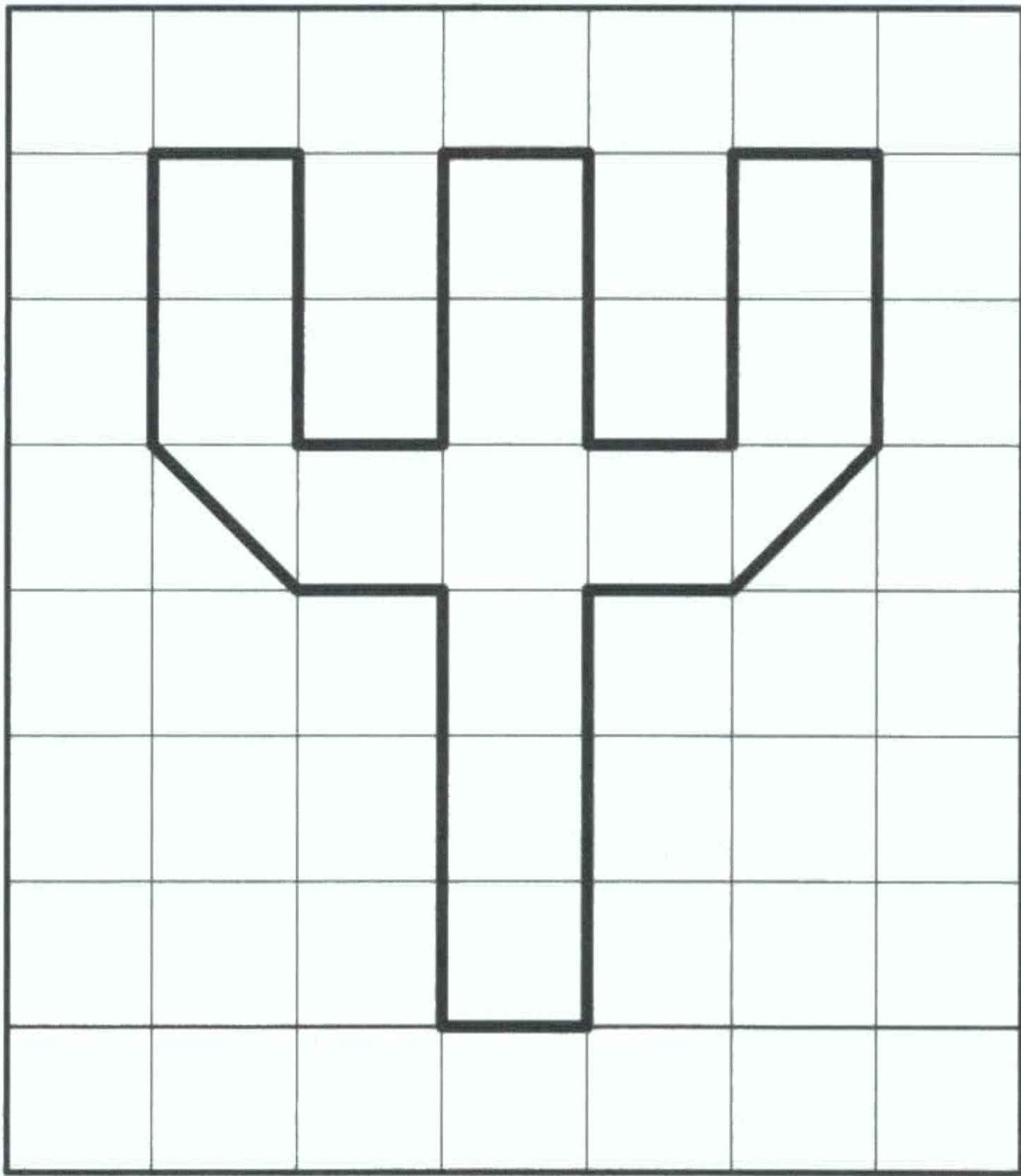

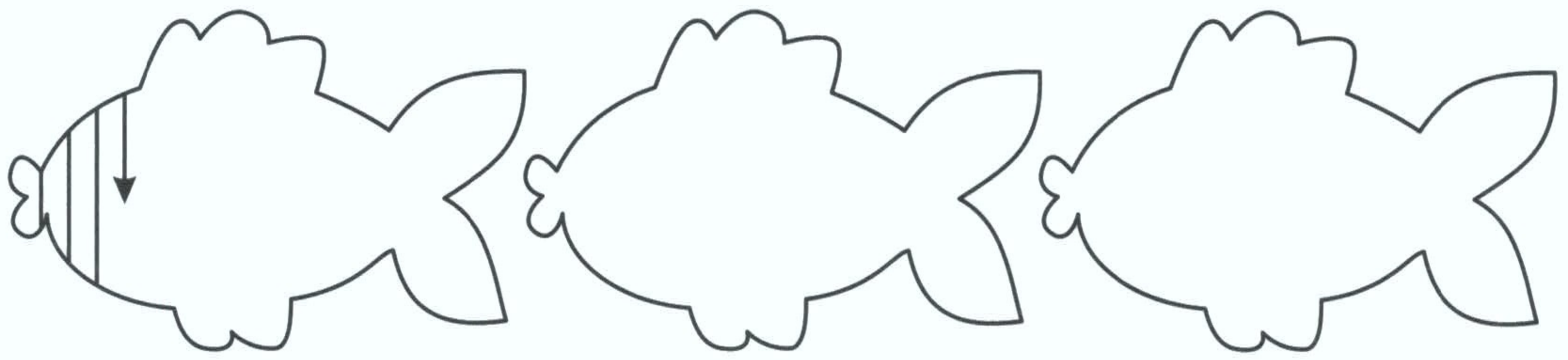

Нарисуй внизу такие же картинки.

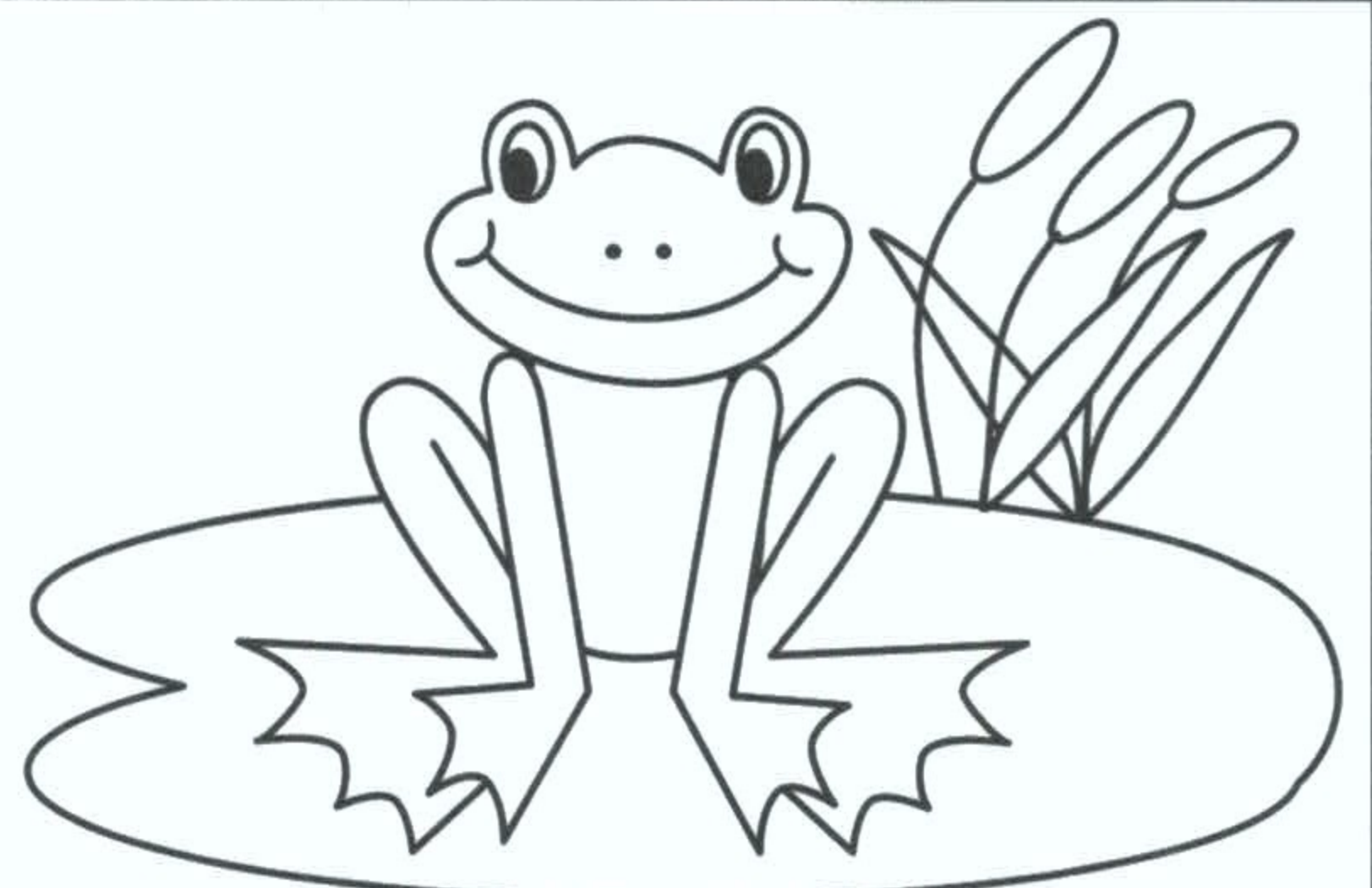
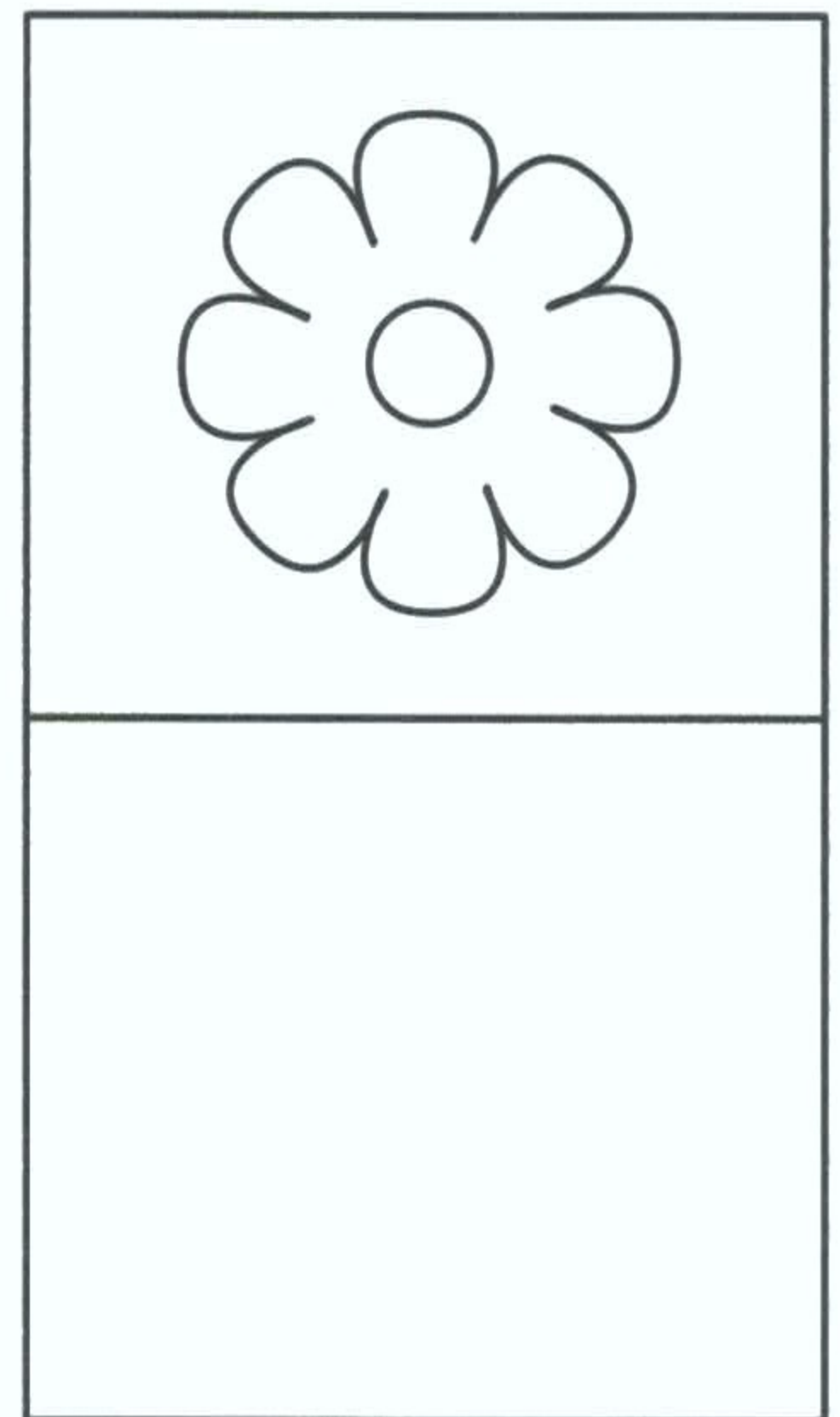
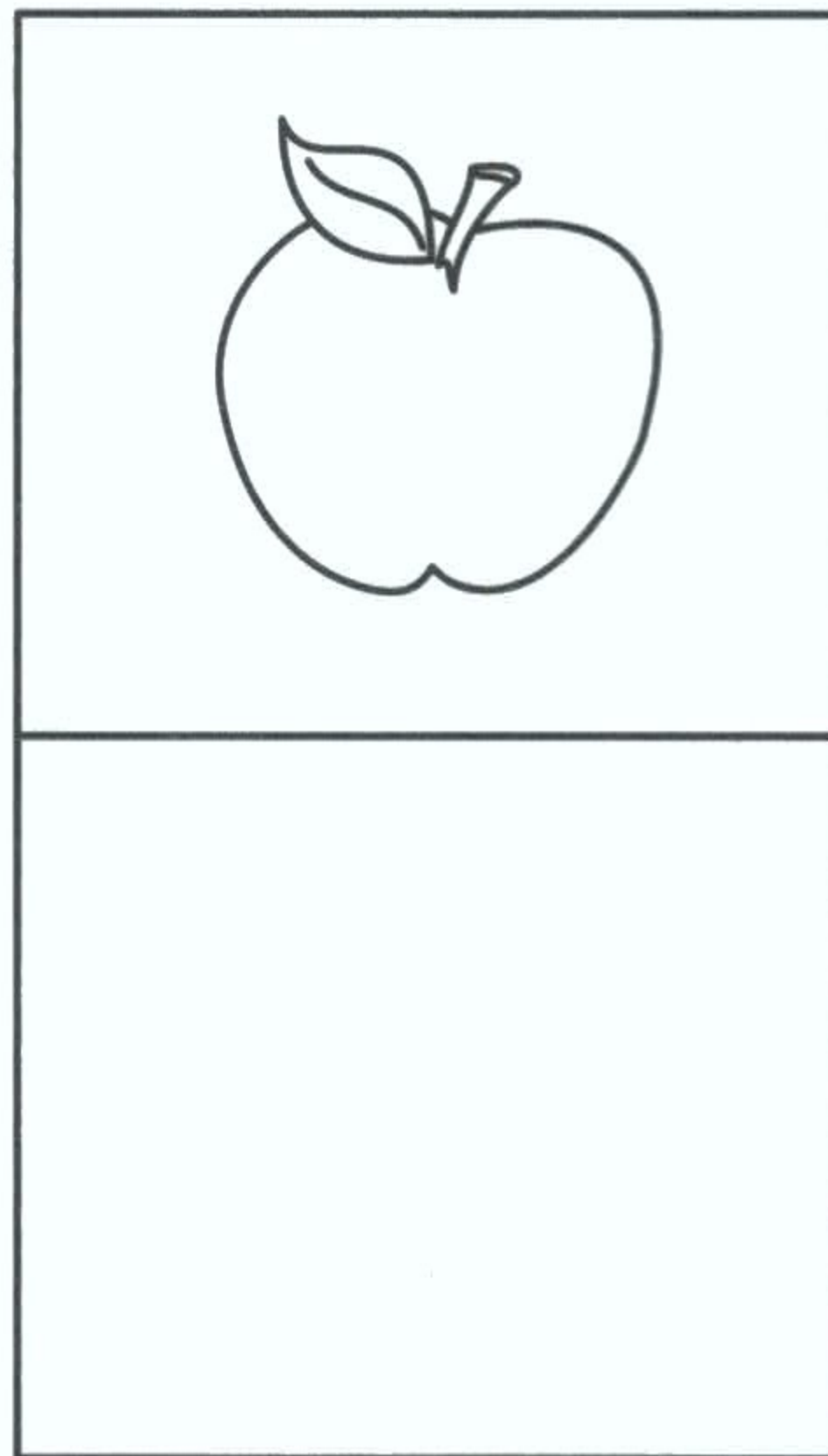
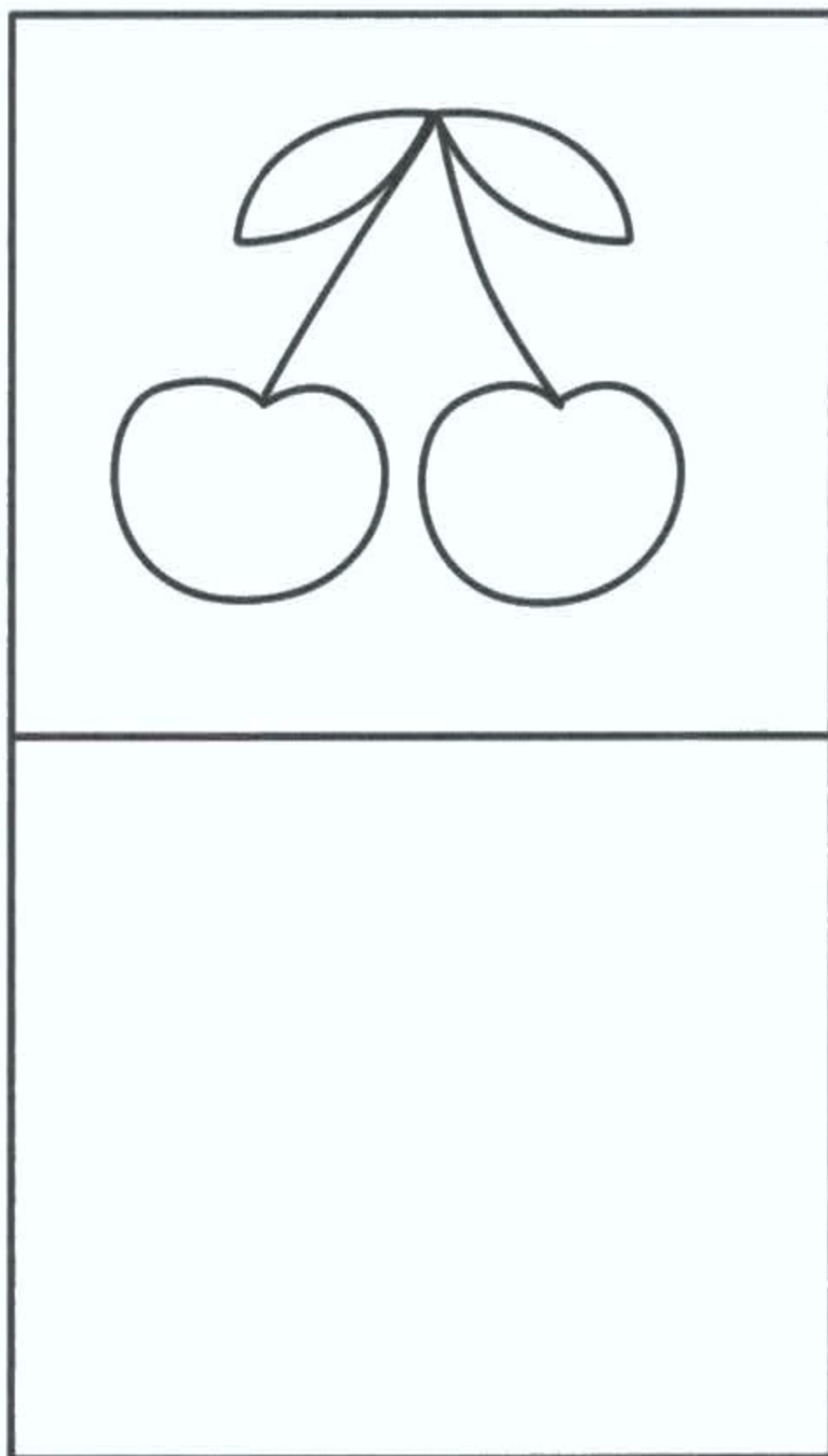

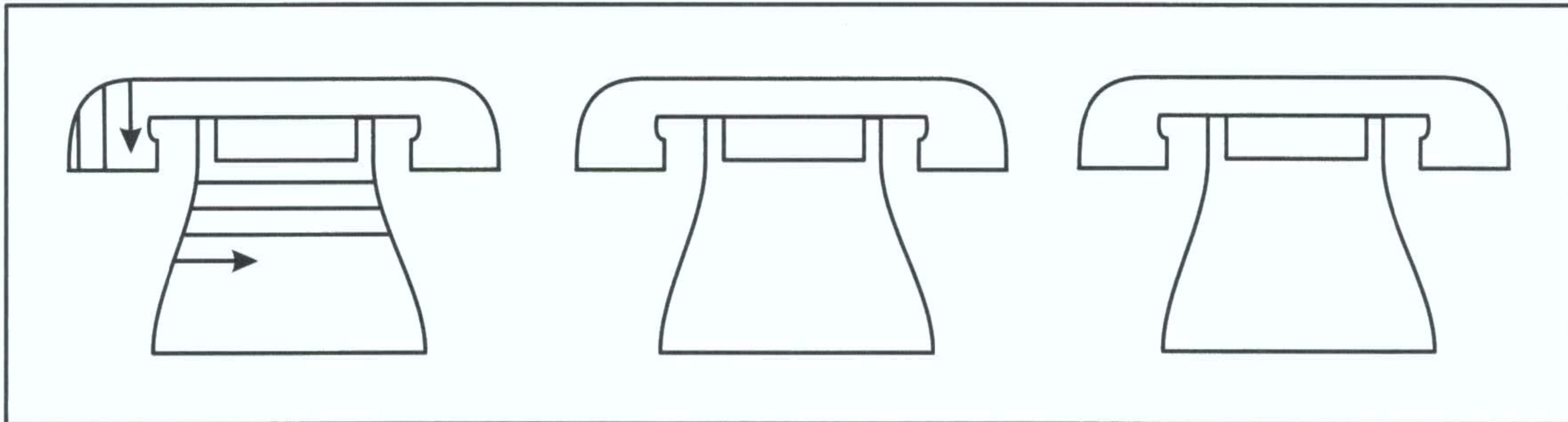

Дорисуй вторую половинку коврика.

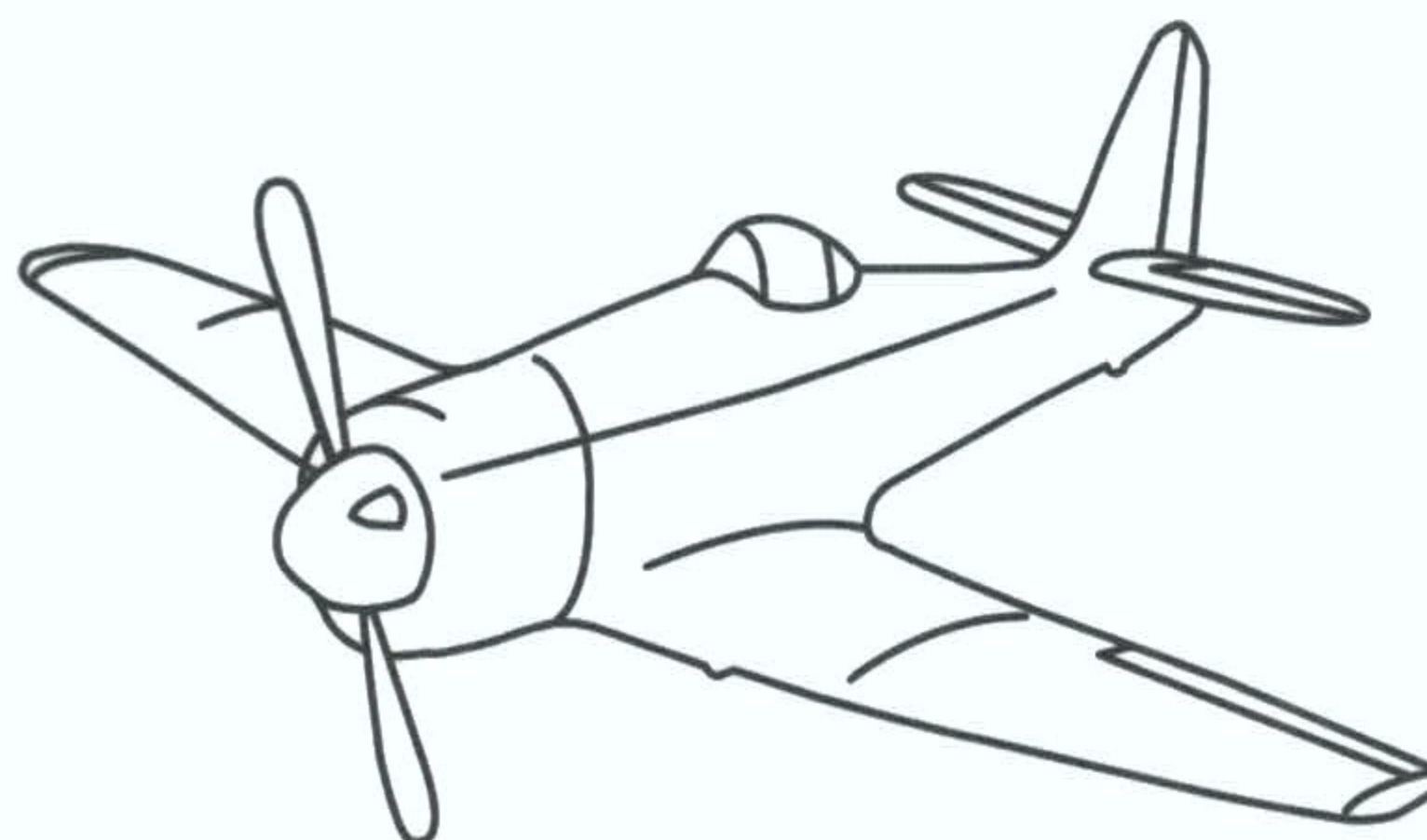
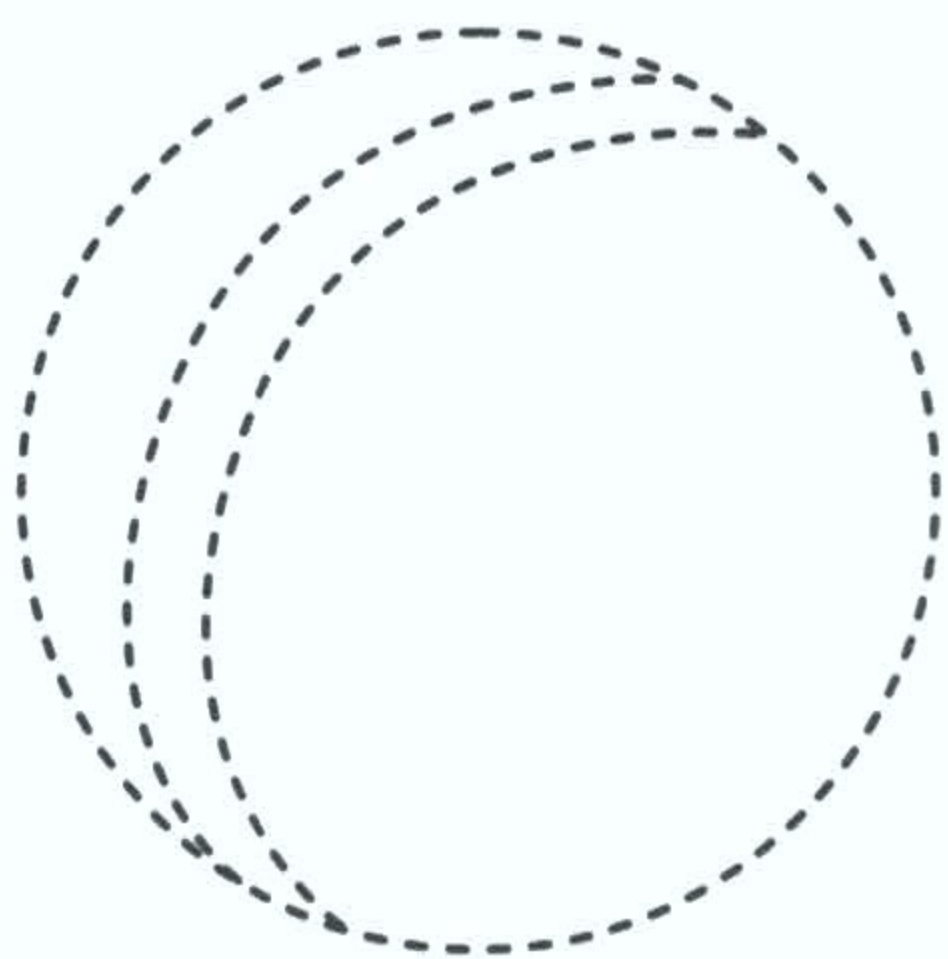
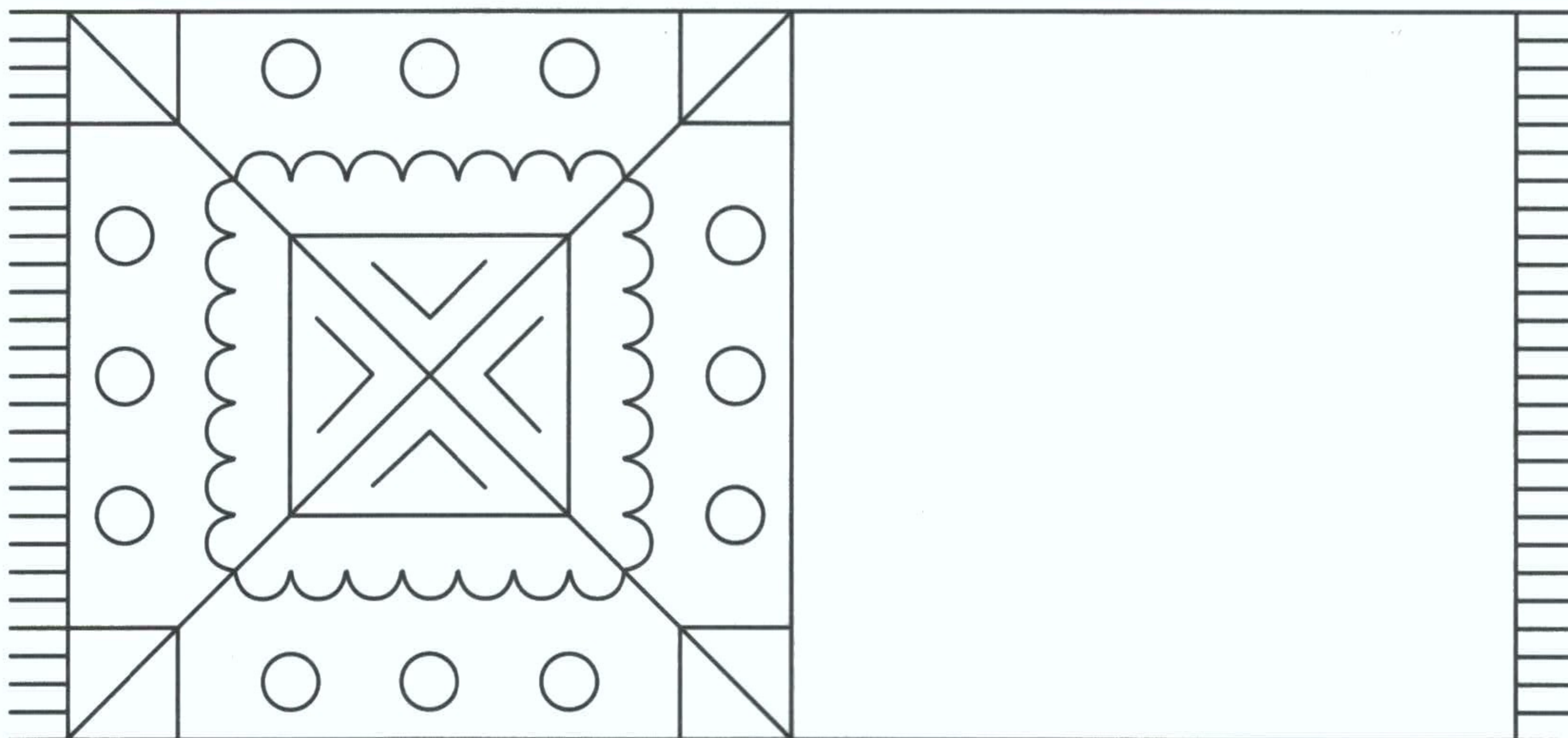

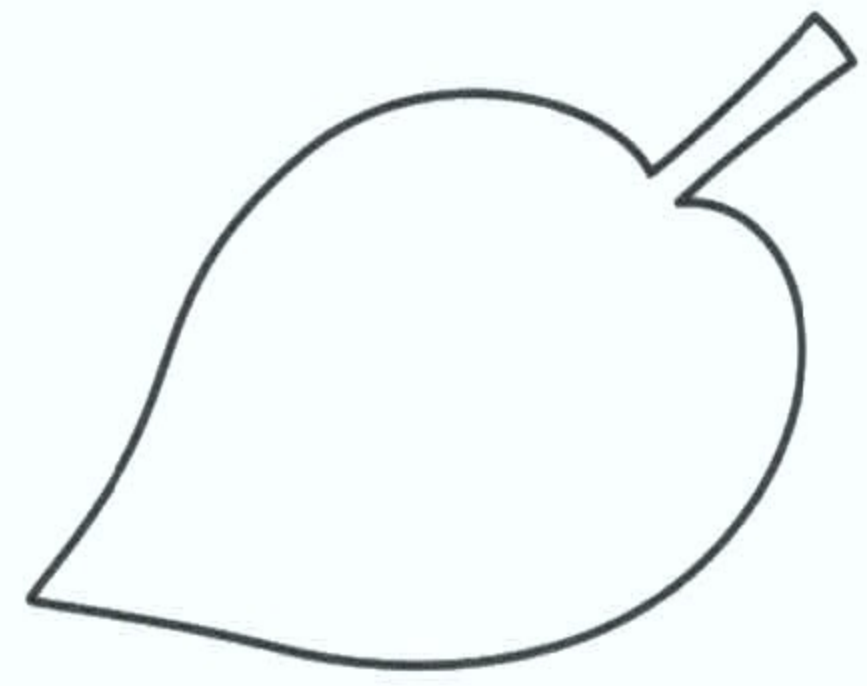
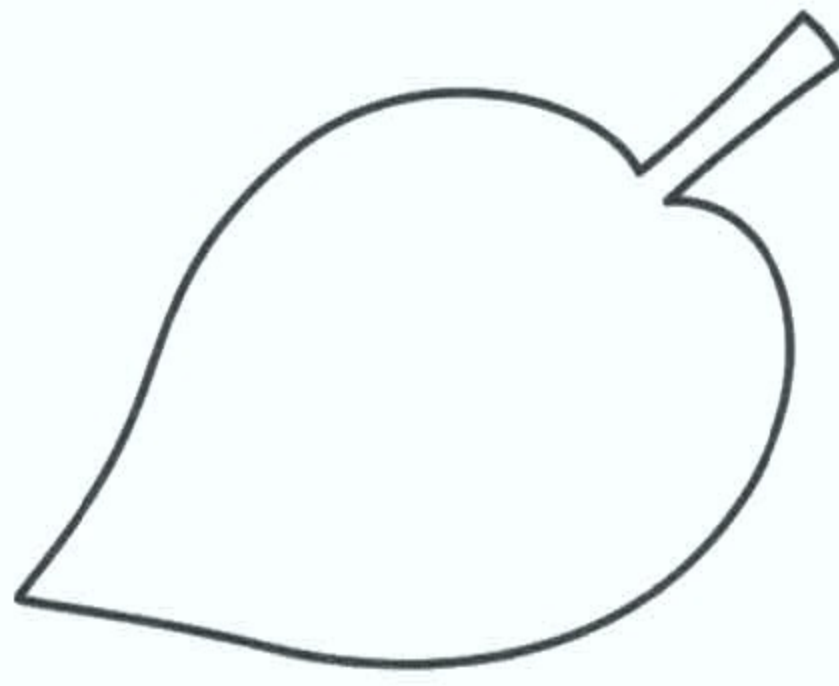
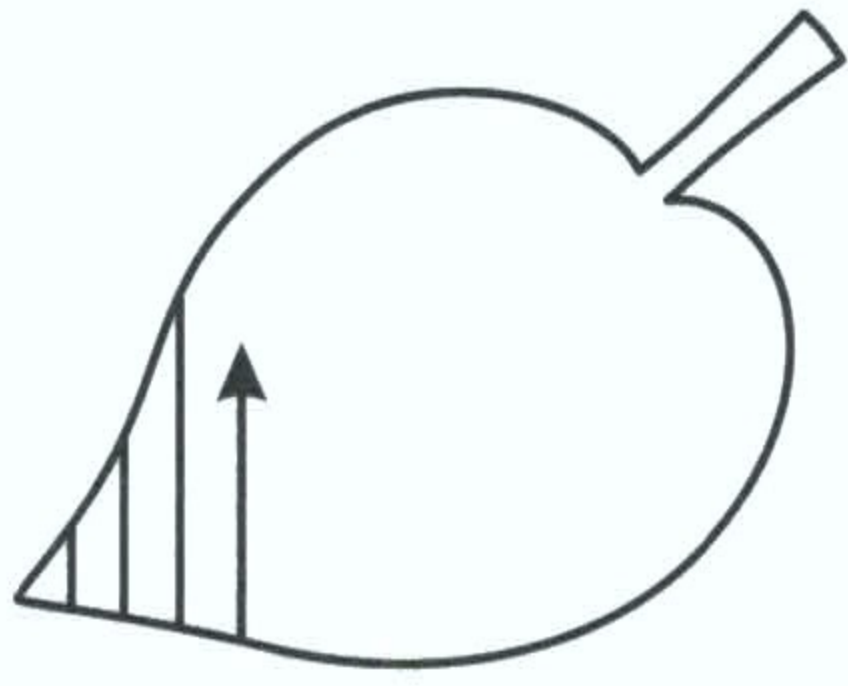

Раскрась картинку.

